

# OmniTom Elite

## User Manual

1-NL5000-060 Revision 18



## 1.1 Contents

Intended use of the system .....	21
Clinical benefit .....	21
Consumer information .....	21
Proprietary rights.....	21
Legal disclaimer .....	21
Contact information .....	22
NeuroLogica Corporation .....	22
Damage in transportation.....	23
User requirements.....	23
Essential performance .....	24
About this user manual .....	24
Identified symbols and system classifications .....	24
Conventions used in this user manual .....	25
Understanding the use of “you” in this user manual.....	26
Active and inactive objects .....	26
Applicable versions of the OmniTom Elite .....	26
Use environment for the OmniTom Elite .....	26
<b>Chapter 1 Compliance and Safety Requirements.....</b>	<b>27</b>
IEC classification and symbols .....	27
Environmental specifications.....	31
Site specification.....	33
Hazardous substances .....	33
Part numbers and product-marking plates .....	34
Class 1 Type B medical devices .....	35
Focal spot .....	36
Filtration .....	36
Source to Detector Distance (SID) .....	36
Compliance statement.....	36
EMI/EMC terms .....	37
Electromagnetic compatibility .....	37
Radio frequency interference .....	38
Susceptibility .....	38
EMI/EMC compliance .....	38

Countermeasures against EMC related issues ..... 42

Use recommendations ..... 45

Installation recommendations ..... 46

Cable shielding and grounding ..... 46

Adjacent components and equipment ..... 46

Static magnetic field limits..... 46

Electrostatic discharge environment and recommendations ..... 47

Facility IT-NETWORK ..... 47

Hazard Information..... 47

General safety considerations and statements..... 47

Laser safety..... 49

Scanner mobility safety ..... 50

Electrical safety..... 51

Mechanical safety..... 52

Radiation safety ..... 53

Fire and explosion safety ..... 54

EMERGENCY STOP button ..... 54

Battery system safety and information ..... 54

Battery component for the base power distribution assembly ..... 57

Maintenance and service ..... 57

Cleaning the system..... 58

Cybersecurity..... 59

Contraindication(s) ..... 59

Personnel privileges and terminology ..... 59

Qualified operator ..... 59

Operator of record..... 59

Scanning privileges ..... 59

Protocol privileges ..... 60

Administrator privileges ..... 60

Clinical operation..... 60

Clinical scanning ..... 60

Clinical protocol..... 60

Kernel ..... 60

---

Chapter 2 System Overview .....	61
OmniTom Elite system .....	61
The LCD touch screen .....	62
The shielding curtains .....	62
The tablet .....	62
The silhouette scan board and universal transfer board .....	63
Parts that potentially come into contact with the patient .....	64
Chapter 3 Basic Scanner Operations .....	65
Powering on and off the OmniTom Elite system .....	65
Overview of the scanner's LCD touch screen .....	65
LCD tabs and icons .....	66
Drive bar calibration for transport .....	69
Moving the scanner for transport .....	71
Using collision avoidance sensors .....	73
Transporting with drive view .....	74
Transporting with mood ring lights .....	76
Positioning the scanner before a scan .....	77
Positioning the patient .....	78
Using alignment camera .....	81
Positioning the scanner using the laser light .....	84
To activate the laser light on the touch screen .....	84
Using the curtains for shielding .....	85
Rebooting the system .....	86
Remote support feature .....	86
Enabling remote support .....	86
Chapter 4 Basic Tablet Operations .....	88
Understanding the types of users .....	88
Powering on the tablet .....	88
Logging in to the tablet .....	89
Locking the tablet with the LCD .....	90
Logging off the tablet .....	92
Powering off the tablet .....	93
Enabling the privacy screen on the tablet .....	94

---

Navigating around the tablet's main screen .....	95
Getting to know the scanner status screen .....	96
System status orbs and mood ring lights .....	98
Getting to know the system screen .....	100
Getting to know the protocol screen .....	101
Getting to know the patient screen .....	102
The tablet tabs.....	103
Tablet buttons.....	103
<b>Chapter 5 System Settings.....</b>	<b>106</b>
System settings overview .....	106
Setting user accounts.....	107
Deleting a user.....	109
Applying dose configuration.....	110
Setting dose notifications .....	110
Editing dose notifications on NL protocols .....	113
Setting dose alerts (system limits) .....	115
Managing DICOM servers.....	116
Setting up the audit trail viewer .....	117
Setting recon presets.....	119
Setting recon preset groups.....	120
Setting MPR presets .....	121
Setting windowing presets .....	123
Selecting image orientation.....	124
<b>Chapter 6 Protocol Manager.....</b>	<b>126</b>
Creating a new protocol .....	126
Adding a New Protocol using Copy from an Existing Protocol.....	130
Editing an existing protocol .....	133
Deleting a protocol .....	135
Hiding protocols .....	137
Moving protocols.....	137
<b>Chapter 7 Daily Calibration and Quality Assurance .....</b>	<b>139</b>
Daily calibration.....	139
Performing a daily calibration.....	139

---

Tube seasoning .....	140
The QA phantom overview .....	141
Performing a quality assurance test .....	143
Ensuring good image quality .....	145
OmniTom Elite dose information (21 CFR 1020.33 c) .....	145
Sample calculation.....	146
The scout dose.....	147
Dose in clinical mode.....	147
OmniTom Elite dose in air.....	148
QA measurements.....	149
Finding high-contrast resolution.....	149
Noise, uniformity, and mean CT number of water .....	150
Uniformity and mean CT number .....	150
Low-contrast resolution.....	150
ACR validation .....	151
Beam width .....	151
Geometric efficiency in the Z axis direction.....	152
Slice sensitivity .....	152
Half-value layer.....	153
Allowable variations .....	154
Scatter radiation .....	154
Scatter exposure.....	155
CTDI measurements .....	157
Dose linearity with tube voltage and current .....	157
Additional scatter measurements.....	158
Chapter 8 Registration.....	160
Navigating the Registration Screen – START HERE .....	160
Registering the patient .....	161
Querying patient information.....	162
Storing patients in the stored list.....	164
Removing patients from the stored list .....	165
Manually registering a patient using ‘Manual Add’ .....	166
Viewing patient information.....	167

---

Chapter 9 Patient Scanning .....	168
Patient scanning overview .....	168
Identifying protocol types.....	169
Axial .....	170
Helical .....	170
Reference.....	170
Scout.....	171
Performing a scan .....	171
Re-using Scouts with a New Protocol .....	176
Repeating an Image .....	178
Scanning with special features .....	179
Using the step & shoot option.....	179
Performing a scan with Automatic Exposure Control (AEC) .....	180
Adding Noise Reduction to Axial Reconstructions.....	183
Performing a CT angiography scan with bolus tracking .....	185
Performing test bolus .....	189
Performing a CT perfusion scan.....	190
Viewing images in the CTP viewer .....	192
Examining the scanned image with tools .....	194
Using tools on the acquisition tab .....	194
Chapter 10 Browser .....	197
Browser overview .....	197
Navigating the browser .....	198
Compare Series.....	198
Loading a series to viewer from the browser .....	200
Deleting a series .....	201
Editing patient details .....	201
Archiving patient images .....	201
Archiving to PACS.....	202
MSU Image Transfer to Hospital .....	204
Chapter 11 Viewer .....	205
Viewer overview .....	205

Setting window width and center .....	208
Viewing images in 2D .....	209
Viewing images in MPR .....	210
Understanding and using slab .....	211
Viewing images in 3D .....	214
Viewing images in CTP .....	215
<b>Chapter 12 Reconstruction .....</b>	<b>219</b>
Reconstruction overview .....	219
Performing a reconstruction .....	220
<b>Chapter 13 Accessories and Options .....</b>	<b>224</b>
Accessories and options overview .....	224
Using bed adapters .....	224
Using bed adapter safety straps .....	225
Attaching bed adapter with or without posts .....	227
Using the removable T-square handle with the bed adapter .....	229
Transfer boards for adult, pediatric, and neonate patients .....	230
Using the universal transfer board and silhouette scan board .....	231
Using the pediatric scan platform .....	233
Using the infant and neonate scanning platform .....	235
Positioning using the infant and neonate scanning platform .....	236
Adjusting the infant and neonate platform handle .....	237
<b>Chapter 14 Using the OmniTom Elite in the Operating Room .....</b>	<b>239</b>
Using the operating room table adapter .....	239
Using the universal transfer board in the OR .....	240
<b>Appendix A Glossary .....</b>	<b>241</b>
<b>Appendix B Error Codes .....</b>	<b>249</b>
<b>Appendix C Emergency Service Kit Procedure .....</b>	<b>258</b>
<b>Introduction .....</b>	<b>258</b>
Purpose .....	258

Lifting the OmniTom.....	258
In Transport Mode .....	258
Jacking Up the OmniTom .....	258
Positioning the Dolly.....	262
Lowering the OmniTom onto the dolly .....	262
In Scan Mode .....	263
Jacking up the OmniTom .....	263
Positioning the Dollies .....	266
Lowering the OmniTom onto the Dolly.....	267
Moving the OmniTom .....	267
Appendix D   Revision History .....	268
Appendix E   Varex Imaging Data .....	271

## List of Figures

Figure 1: Scanner dimensions .....	34
Figure 2: Product marking plate.....	35
Figure 3: Laser safety symbol.....	49
Figure 4: Dangerous to patient and operator label.....	53
Figure 5: Tablet battery capacity icon .....	56
Figure 6: Acquisition, positioning, and transport tabs on the LCD touch screen .....	62
Figure 7: OmniTom Elite tablet .....	63
Figure 8: Tablet safe distance location (two views).....	63
Figure 9: Silhouette scan board and universal transfer board.....	64
Figure 10: Acquisition tab .....	66
Figure 11: Positioning tab .....	66
Figure 12: Transport tab.....	66
Figure 13: Initial screen when drive bar calibration begins.....	70
Figure 14: Retry calibration screen .....	70
Figure 15: Drive bar calibration failed .....	70
Figure 16: Active transport tab on LCD .....	71

Figure 17: Transport mode.....	72
Figure 18: Drive bar motions .....	73
Figure 19: Enabled collision avoidance sensors .....	74
Figure 20: Disable collision sensor icon .....	74
Figure 21: Mute audible alerts icon .....	74
Figure 22: Optional drive view camera .....	75
Figure 23: System icon .....	75
Figure 24: System settings icon.....	75
Figure 25: System settings.....	75
Figure 26: Drive view .....	76
Figure 27: Entering drive view pop-up.....	76
Figure 28: Front of OmniTom Elite with mood ring light enabled.....	77
Figure 29: Mood ring light enable/disable feature .....	77
Figure 30: Active positioning tab on LCD .....	78
Figure 31: Bed adapter without posts insertion.....	79
Figure 32: Bed adapter with T-square.....	79
Figure 33: Attaching the scan board with bed adapter to patient's bed .....	80
Figure 34: Positioning the patient on the bed.....	80
Figure 35: Ensuring placement of patient's neck directly under laser light .....	80
Figure 36: OmniTom Elite alignment camera.....	81
Figure 37: QR code alignment indicators .....	81
Figure 38: Adult scan board .....	82
Figure 39: Align icon.....	82
Figure 40: Looking for alignment markers .....	82
Figure 41: Alignment found .....	83
Figure 42: Alignment not found.....	83
Figure 43: Alignment moving.....	83
Figure 44: Alignment complete.....	84
Figure 45: Power down pop-up.....	86
Figure 46: Enable remote support .....	86
Figure 47: Enable remote support prompt .....	87
Figure 48: Disable remote support .....	87
Figure 49: Disable remote support prompt .....	87

Figure 50: Login panel ..... 89

Figure 51: Tap to logIn prompt..... 89

Figure 52: Access denied prompt..... 89

Figure 53: Registration tab ..... 90

Figure 54: Automatic lock out screen ..... 91

Figure 55: System lock button..... 91

Figure 56: Login screen on LCD ..... 92

Figure 57: System icon ..... 92

Figure 58: Logout icon..... 92

Figure 59: Confirm logout prompt ..... 93

Figure 60: System icon ..... 93

Figure 61: Shutdown icon ..... 93

Figure 62: Confirm shutdown prompt..... 94

Figure 63: System icon ..... 94

Figure 64: System screen ..... 94

Figure 65: Privacy screen ..... 95

Figure 66: Scanner status screen ..... 96

Figure 67: Mood ring light..... 99

Figure 68: System screen ..... 100

Figure 69: Protocol screen ..... 102

Figure 70: Patient screen ..... 102

Figure 71: Tablet tabs to perform a patient examination..... 103

Figure 72: System icon ..... 107

Figure 73: System Settings icon..... 108

Figure 74: Manager Users icon ..... 108

Figure 75: Manage Users dialog box ..... 108

Figure 76: System icon ..... 109

Figure 77: System Settings icon..... 109

Figure 78: Manager Users icon ..... 109

Figure 79: Manage Users dialog box ..... 109

Figure 80: Delete pop up..... 110

Figure 81: System icon ..... 111

Figure 82: Protocol manager icon ..... 111

Figure 83: Adult or pediatric selection .....	111
Figure 84: Body part selection .....	111
Figure 85: Protocol selection .....	111
Figure 86: Edit icon .....	111
Figure 87: Series selection .....	111
Figure 88: Max field selection .....	112
Figure 89: Update icon .....	112
Figure 90: Save icon .....	112
Figure 91: Close button .....	112
Figure 92: Dose notification message .....	113
Figure 93: Diagnostic reason dialog box .....	113
Figure 94: System icon .....	113
Figure 95: System setting icon .....	114
Figure 96: Dose configuration icon .....	114
Figure 97: Dose configuration dialog box .....	114
Figure 98: Entering mGy and mGy.cm values .....	114
Figure 99: Define dose alert .....	115
Figure 100: Dose alert .....	115
Figure 101: Dose alert dialog box .....	116
Figure 102: PACS Configuration icon .....	117
Figure 103: PACS configuration dialog box .....	117
Figure 104: Audit Trail Viewer icon .....	118
Figure 105: Audit trail viewer dialog box .....	118
Figure 106: Calendar dialog box .....	118
Figure 107: Audit trail viewer options .....	119
Figure 108: Recon Presets icon .....	119
Figure 109: Recon presets dialog box .....	119
Figure 110: New preset dialog box .....	120
Figure 111: Recon Groups icon .....	120
Figure 112: Recon preset groups dialog box .....	121
Figure 113: New recon preset group dialog box .....	121
Figure 114: MPR Presets icon .....	122
Figure 115: MPR presets dialog box .....	122

Figure 116: New MPR preset dialog box .....	122
Figure 117: Window Presets icon.....	123
Figure 118: Window preset options.....	123
Figure 119: Window preset option .....	123
Figure 120: Image orientation.....	124
Figure 121: Patient orientation toggle .....	125
Figure 122: Orientation verification dialog .....	125
Figure 123: Protocol manager for adult and pediatric patients .....	126
Figure 124: Protocol Manager New Protocol.....	127
Figure 125: New protocol dialog box .....	127
Figure 126: New series dialog box .....	128
Figure 127: Protocol manager.....	131
Figure 128: Copy Protocol.....	132
Figure 129: Copied Protocol.....	132
Figure 130: Save Modified Protocol .....	132
Figure 131: Copied Protocol.....	133
Figure 132: Save Copied Protocol.....	133
Figure 133: Edit button illuminated .....	134
Figure 134: Edit protocol dialog box .....	135
Figure 135: Protocol manager with a protocol selected for deleting .....	136
Figure 136: Delete protocol icon.....	136
Figure 137: Delete protocol confirmation pop-up .....	136
Figure 138: Protocol manager hide protocol function .....	137
Figure 139: Protocol manager move protocol function .....	138
Figure 140: Daily calibration dialog box .....	140
Figure 141: Daily calibration progress pop-up .....	140
Figure 142: Daily calibration status.....	140
Figure 143: Tube seasoning prompt.....	141
Figure 144: Tube seasoning dialog box .....	141
Figure 145: QA phantom.....	142
Figure 146: Phantom's etchings appear on top and sides.....	144
Figure 147: Quality assurance dialog box .....	144
Figure 148: Quality assurance results .....	145

Figure 149: MTF at isocenter, shown for high resolution .....	149
Figure 150: MTF at standard kernel .....	149
Figure 151: CatPhan 515 using 120kV, 45mA, 2 secs, and 5mm slice .....	150
Figure 152: CatPhan 515 scanned using 120kV, 45mA, 2 secs and 5mm slice .....	151
Figure 153: The measured beam width of the OmniTom Elite scanner .....	152
Figure 154: OmniTom Elite dose profile .....	152
Figure 155: The sagittal reformat of the ACR scan using 0.625mm slices .....	153
Figure 156: Slice sensitivity profile of 0.625mm axial scan of the ACR bead phantom .....	153
Figure 157: The scatter measurement setup .....	155
Figure 158: The isodose curves for 120 kV, 70 mAs (using the CTDI 16cm phantom).....	156
Figure 159: The pediatric body phantom.....	156
Figure 160: Active registration tab.....	160
Figure 161: Registration dialog box.....	160
Figure 162: Registration tab .....	162
Figure 163: Query information dialog box .....	162
Figure 164: Query fields.....	163
Figure 165: Registration query results table .....	164
Figure 166: Registration stored results table .....	165
Figure 167: Stored list .....	165
Figure 168: Manual Add button.....	166
Figure 169: Manually Add Pt Info Dialog Box.....	166
Figure 170: Active acquisition tab.....	168
Figure 171: Radiographic film of the 60mm scan coverage .....	170
Figure 172: Scan coverage and imaged region for a true coverage of 60mm .....	170
Figure 173: Illuminated accept icon .....	172
Figure 174: Exam planner dialog box .....	172
Figure 175: Protocol series dialog box .....	173
Figure 176: Ready, press 'scan' on scanner .....	173
Figure 177: Initiate scan on LCD.....	174
Figure 178: Setting scout parameters .....	174
Figure 179: Ready, press 'scan' on scanner .....	175
Figure 180: Complete dialog box .....	176
Figure 181: Scan Complete .....	176

Figure 182: Start New .....	177
Figure 183: Reuse Scout.....	177
Figure 184: Accept new protocol .....	177
Figure 185: Begin .....	178
Figure 186: Reused Scout.....	178
Figure 187: Repeat scan pop up.....	179
Figure 188: Step & Shoot dialog box.....	180
Figure 189: Options dialog box with AEC enabled .....	181
Figure 190: Toggle AEC graph icon .....	182
Figure 191: AEC graph.....	182
Figure 192: mA modulation .....	183
Figure 193: Options.....	183
Figure 194: Noise Reduction .....	184
Figure 195: Noise Reduction Levels .....	184
Figure 196: Save .....	184
Figure 197: Dynamic-CTA options .....	185
Figure 198: Parameters on scout .....	186
Figure 199: Series boxes.....	186
Figure 200: Active scan regions on scout .....	187
Figure 201: Bolus ROI.....	187
Figure 202: Completed CTA.....	188
Figure 203: Parameters on scouts.....	189
Figure 204: Bolus timing graph .....	190
Figure 205: CT perfusion dynamic scan options.....	191
Figure 206: Set dynamic CTP scan location.....	191
Figure 207: Review completed scan.....	192
Figure 208: Active browser tab .....	197
Figure 209: Browser studies and series tables .....	198
Figure 210: Compare Series Arrow .....	198
Figure 211: Compare Series Viewer .....	199
Figure 212: Series Selection Buttons.....	199
Figure 213: Series Selection Dropdowns.....	200
Figure 214: 2D viewer .....	200

Figure 215: Delete pop up.....	201
Figure 216: Edit patient details .....	201
Figure 217: Archive pop up .....	202
Figure 218 Select the PACS server.....	202
Figure 219: PACS queue dialog box.....	203
Figure 220: MSU Image Transfer to Hospital.....	204
Figure 221: Active viewer tab.....	205
Figure 222: 2D, 3D, MPR, and CTP viewing tab.....	208
Figure 223: Windowing preset list, text boxes, and the apply button.....	209
Figure 224: 2D tools .....	209
Figure 225: MPR tools.....	210
Figure 226: Coronal, sagittal, and transverse plane options .....	211
Figure 227: Set the cyan lines .....	212
Figure 228: Slab option .....	212
Figure 229: Using the tilt tool .....	213
Figure 230: Capture dialog box .....	214
Figure 231: 3D viewing.....	215
Figure 232: Dynamic CTP viewer.....	216
Figure 233: Arterial and venous ROI's.....	217
Figure 234: Adjust position of ROI .....	218
Figure 235: Perfusion maps .....	218
Figure 236: Active reconstruction tab.....	219
Figure 237: Reconstruction areas.....	220
Figure 238: Reconstruction studies and series tables .....	221
Figure 239: Reconstruction viewing pane .....	221
Figure 240: Post reconstruction's parameters .....	222
Figure 241: Select modifications .....	222
Figure 242: Reconstruction parameters slice thickness/spacing dropdown .....	223
Figure 243: Bed adapter without posts (left) and bed adapter with posts (right) .....	225
Figure 244: Safety straps.....	225
Figure 245: Hill Rom bed adapter .....	225
Figure 246: Stryker In Touch bed adapter .....	226
Figure 247: Straps attached to bed adapter.....	226

Figure 248: Silhouette scan board attached to bed adapter .....	227
Figure 249: Patient properly immobilized on scan board .....	227
Figure 250: Bed adapter T-square handle .....	228
Figure 251: Bed adapter without posts insertion (setscrew showing under arrow) .....	228
Figure 252: Bed adapter without posts shown being inserted into scan board .....	228
Figure 253: Silhouette with cushion shown on head holder .....	229
Figure 254: Steps showing removing T-square handle.....	229
Figure 255: Steps showing reattaching T-square handle .....	230
Figure 256: Correct install depth.....	230
Figure 257: Universal transfer board and stiffeners .....	232
Figure 258: Four types of mattress stiffeners.....	232
Figure 259: Mattress stiffener in place.....	232
Figure 260: Universal transfer board properly positioned on the bed on a mattress stiffener .....	233
Figure 261: Universal transfer board with safety strap installed.....	233
Figure 262: Pediatric scan platform .....	234
Figure 263: Child placed on pediatric platform with safety strap (two views) .....	234
Figure 264: Platform brake.....	235
Figure 265: Infant and neonatal scan platform .....	235
Figure 266: Pediatric strap .....	236
Figure 267: Applying pediatric strap onto the platform (three views) .....	236
Figure 268: Proper position of neonate/infant for head scans (left) and body scans (right).....	236
Figure 269: Neonate platform foot brake location.....	237
Figure 270: Locking pins for the handle .....	237
Figure 271: Three positions for the platform handle .....	238
Figure 272: OR table adapter .....	239
Figure 273: OR table adapter attached to mount .....	239
Figure 274: Jack Components .....	258
Figure 275: Closeup of Release Valve.....	259
Figure 276: Placement of space block.....	259
Figure 277: Using the release valve.....	260
Figure 278: Inserting the jack bar.....	261
Figure 279: Proper placement of Jack.....	261
Figure 280: Move the dollies into place .....	262

---

Figure 281: Correct placement of Omniwheel on dolly ..... 262

Figure 282: Jack Components ..... 263

Figure 283: Using the release valve..... 264

Figure 284: Inserting the jack bar..... 265

Figure 285: Jacking up the Scanner ..... 265

Figure 286: Correct placement of Omniwheel on dolly ..... 266

Figure 287: Proper placement of dolly..... 266

## List of Tables

Table 1: Conventions used in this user manual .....	25
Table 2: Applicable IEC symbols .....	28
Table 3: Operating environment .....	31
Table 4: Site specification .....	33
Table 5: System operating parameters .....	33
Table 6: Battery operating parameters .....	33
Table 7: Hazardous substances table .....	33
Table 8: Core-system-component part numbers and product-marking plate locations .....	34
Table 9: Core-system component dimensions and weight .....	34
Table 10: Acronyms and abbreviations .....	38
Table 11: Emission declaration for OmniTom Elite system .....	40
Table 12: EMC immunity declaration for the OmniTom Elite system .....	40
Table 13: EMC immunity declaration .....	43
Table 14: Recommended separation distances .....	44
Table 15: Test specifications for ENCLOSURE PORT IMMUNITY to RF wireless communications equipment .....	44
Table 16: Tablet display dimensions .....	63
Table 17: Icons on acquisition, positioning, and transport tabs and actions .....	67
Table 18: Constant screen elements .....	95
Table 19: Status bar identification .....	97
Table 20: System state orbs and corresponding mood ring light colors .....	99
Table 21: System options .....	100
Table 22: Registration tab buttons and functions .....	103
Table 23: Acquisition tab buttons and functions .....	104
Table 24: System configuration settings .....	106
Table 25: Anatomical orbs .....	134
Table 26: Scan protocols used by the QA .....	143
Table 27: OmniTom Elite CTDI100 values .....	146
Table 28: Scan voltage weighting factors for dose calculations .....	146
Table 29: The clinical dose measurement .....	148
Table 30: kV vs. dose in air .....	148
Table 31: The CT values for the ACR inserts at different kV levels. ....	151

Table 32: Half-value layer .....	153
Table 33: The energy conversion rates .....	155
Table 34: The detailed dose measurement in a clinical scan mode .....	157
Table 35: Exposure at two different mAs .....	157
Table 36: Exposure at two different mAs .....	158
Table 37: Linearity calculations (mGy) .....	158
Table 38: Linearity calculations in accordance with IEC .....	158
Table 39: Scatter in vertical parallel to axis of rotation ( $\mu\text{Rem/s}$ ).....	159
Table 40: Scatter in vertical plane on patient side (mRem/s) .....	159
Table 41: Registration buttons .....	161
Table 42: Acquisition buttons.....	168
Table 43: Bolus tracking icons .....	185
Table 44: Bolus tracking tool table.....	188
Table 45: CTP Viewer Tools .....	192
Table 46: Image tools .....	194
Table 47: Command buttons .....	197
Table 48: Store/print queue buttons.....	203
Table 49: Common tools .....	205
Table 50: MPR tools .....	207
Table 51: 3D tools .....	207
Table 52: MPR Options.....	212
Table 53: CTP Viewer Tools .....	216
Table 54: Reconstruction tools.....	219
Table 55: Scan boards and their weight-bearing restrictions .....	231
Table 56: Error code list .....	249

---

## Intended use of the system

The OmniTom Elite computed tomography (CT) system is intended to be used for x-ray computed tomography applications for anatomy that can be imaged in the 40 cm aperture, primarily head and neck.

The CT system is intended to be used for both pediatric and adult imaging and as such has preset dose settings based upon weight and age. The CT images can be obtained either with or without contrast.

---

## Clinical benefit

Computed Tomography (CT) provides real time imaging of bone, soft tissue and blood vessels that can provide detailed information to diagnose, plan treatment for, and evaluate many conditions in adults and children. Additionally, the detailed images provided by CT scans may eliminate the need for exploratory surgery.

---

## Consumer information

### Proprietary rights

NeuroLogica® is a registered trademark of NeuroLogica Corporation, a subsidiary of Samsung Electronics Co., Ltd., in the United States, other countries, or both. CatPhan® is a registered trademark of Phantom Laboratory, Inc. Doro® is a registered trademark of pro med instruments, Inc.

### Legal disclaimer

This user manual is intended as a guide for material supplied by NeuroLogica Corp. It provides the operator (you) with the necessary information to carry out specific procedures and maintain NeuroLogica produced equipment. Use this manual in conjunction with instruction and training supplied by qualified NeuroLogica personnel.

Any information or descriptions contained in this manual may not be reproduced and released to any of the general public or used in conjunction with other professional instruction without written consent of NeuroLogica Corp., USA – a subsidiary of Samsung. Direct any written inquiries to the appropriate address found in the section “Contact information” on page 22.

Unauthorized copying of this user manual may not only infringe copyright but also reduce the ability of NeuroLogica Corp. to provide accurate and up-to-date information to users: limited and restricted operators, and administrators.

This user manual, though complete and accurate, may not provide answers to undocumented changes or unexpected results that could occur from system anomalies.

---

## Contact information

Keep user information readily available to contact Customer Service about general assistance or reporting on serious incidents (should they occur).

In the case of a serious incident or adverse event, please notify NeuroLogica at the below contact information and establishments local competent authorities.

To provide any comments, suggestions, or corrections to this user manual, please write to and include chapter title and page number:

---

## NeuroLogica Corporation

Customer Service	14 Electronics Avenue, Danvers, MA 01923 USA
USA and Canada	1-888-564-8561
International	1-978-564-8561
Email	<a href="mailto:support@neurologica.com">support@neurologica.com</a>

**Note:** If you have questions about the clinical use of your system, speak with the **Clinical Representative**.

If you have questions about the service or functional operation of the system, speak with the **Technical Representative**.

Winckels Medical Devices Expertise	Australian Sponsor	Brazilian Authorized Distributor
<p>Europe Bergerweg 18 6085 AT Horn The Netherlands</p> <p>+31 (0)475 582285 Tel</p> <p>+31 (0)475 582278 Fax</p> <div data-bbox="404 762 623 835" style="border: 1px solid black; padding: 2px; display: inline-block;"> <span style="margin-right: 10px;">EC</span> <span>REP</span> </div> <div data-bbox="448 869 574 1010" style="text-align: center;">  </div>	<p>Level 8/15 Talavera Road PO Box 646 North Ryde NSW 2113 Australia</p> <p>M +61 (0)412 563 016 Tel T +61 (0)2 8114 1535 Tel F +61 (0)2 8114 1599 Tel</p> <p>Customer Service 1-800 060 168</p>	<p>VR Medical Importadora e Distribuidora de Produtos Médicos Ltda</p> <p>Rua Batataes, 391, conj. 11, 13 e 8º andar</p> <p>CEP: 01423-010 – São Paulo</p> <p>CNPJ: 04.718.143/0001-94</p> <p>Resp. Técnica: Dra. Cristiane Aparecida de Oliveira Aguirre- CRF-SP 21079</p> <p>Registro ANVISA nº: 80102511464</p>

## Damage in transportation

Closely examine all packages at the time of delivery. If you see damage, notate “**damage in shipment**” on all copies of the freight bill **before** you accept or sign for delivery (by the hospital receiving agent).

Whether damage is noted immediately or concealed (noticed after delivery), damage **MUST** be reported to carrier **immediately** upon discovery, or within 14 days after receipt, and content and containers held for inspection by carrier.

Keep in mind – the transportation company **will not** pay a claim for damage if an inspection is not requested within the 14-day period.

## User requirements

The equipment can *only* be operated by users who have received professional medical education and training, such as physicians, radiologists, and other medical specialists.

You, the user (the limited or restricted operator or the administrator), are a trained person who is certified to operate such systems **before** scanning or diagnosing patients.

This training must include medical and x-ray education, and NeuroLogica applications training.

Everyone who uses this equipment must read, understand, and follow all instructions, precautions, and warnings.

Keep this user manual near the equipment. It is important to review the procedures and safety precautions periodically.

---

## Essential performance

The OmniTom Elite offers the following essential performance factors for the system:

- Over radiation protection
- Rescan prevention
- Stray radiation exposure prevention
- Diagnostic performance

---

## About this user manual

The instructions in this user manual describe how to use the NeuroLogica OmniTom Elite **Computed Tomography (CT)** system, manufactured by NeuroLogica Corp. OmniTom Elite is the trade name for the CT system and NL5000 is the device model.

This user manual **does not** provide medical explanations but does suggest potential applications for some of the software features. This user manual describes potential safety problems and how to avoid them.

Anyone who operates this system should have received training **before** attempting to scan or diagnose patients, to include medical and x-ray education, in addition to NeuroLogica applications training.

This manual is made available in electronic format to the customer as part of each product delivery. For electronic manuals, please go to: [Forms.samsungneurologica.com](https://Forms.samsungneurologica.com). Click on “Downloads” and choose “CT Manuals”. The site will ask for the serial number of your product and a password. The password can be provided by Field Service.

Translation of this manual is available for any country that does not allow for English labeling. Please reach out to NeuroLogica directly if translation is required.

## Identified symbols and system classifications

The specifications and details of this user manual may change in order to improve the product or to enhance its performance.

Throughout this user manual, a yellow triangle with a black border and exclamation point is used to draw attention to those conditions or situations that fit one or more of the following criteria, which are definitions from ANSI Z535.5:



**DANGER** Indicates a hazardous situation, which if not avoided, will result in death or serious injury.



**WARNING** Indicates a hazardous situation, which if not avoided, could result in death or serious injury.



**CAUTION** Indicates a hazardous situation, which if not avoided, could result in minor or moderate injury.

## Conventions used in this user manual

Table 1: Conventions used in this user manual

Convention	Use
Commands to perform actions	To perform a string of commands, this user manual will present them as follows: <b>Customize &gt; System.</b> This means click <b>Customize</b> and then click <b>System</b> .
<b>Bold</b>	When content refers to commands, windows, screens, dialog boxes, pop-ups, tabs, buttons, options, keyboard keys, statuses, and modes, these items appear in <b>bold</b> for faster identification, especially in a procedure.
<i>Italic</i>	Identifies a word that is emphasized for your attention.
Numbered steps	Numbered paragraphs represent sequential steps that require you to take action <b>in the sequence provided</b> – unless otherwise instructed. Procedures that are numerical mean that the sequence is important to follow. You may perform some procedures out of the recommended sequence; however, the results may vary.
Notes	The appearance of a note is as such: <b>Note:</b> Indicates additional information to help you operate this product.
Hyperlink (an electronic cross-reference)	A cross reference appears in the electronic (.pdf) user manual as a hyperlink. To retrieve an electronic copy of this user manual (in .pdf), click <b>Help &gt; User Manual</b> from the workstation. A hyperlink is a quick way to go to another area of the user manual (the referred-to content) with a simple click. Hyperlinks appear like this: “Understanding the types of users” on page 88. In this case, hover the mouse pointer over the (gray) hyperlink text. The pointer changes to  . Press the Ctrl key on your keypad and (simultaneously) left click the mouse button. After you left click the hyperlink, the hyperlink takes you to the referenced area in the user manual.

## Understanding the use of “you” in this user manual

Unless specifically noted, the implied “you”, in this user manual, is the user. It is assumed users/operators are certified and medically trained personnel, qualified to use these systems. If the user is not the (implied) operator, the user will be specifically identified as administrator.

The following identifies those actions each user is permitted to perform:

<b>Administrator</b>	Full access permission (rights) to the system and its configuration. Can create protocols, user names and passwords, and all functions of the system.
<b>Limited operator</b>	Modified access permission (rights). Can modify protocols during system use but cannot create and save protocols; has no access to system configuration.
<b>Restricted operator</b>	No access to create, modify, save, or delete protocols; has no access to system configuration.

## Active and inactive objects

When a menu command is dim the item is not active (that is, not enabled). Menu commands can include options, buttons, tabs, etc. When the item is dim, it can mean additional and required tasks must be completed first or you do not have permission to complete the action. Inactive commands, buttons, and tabs are gray. An active menu command, option, button, tab, and field means you can use the item to perform an action. Active items are blue and/or highlighted, not dim.

## Applicable versions of the OmniTom Elite

This User Manual contains information for all versions of the NL5000 including OmniTom Elite, and OmniTom Elite with the SmartMSU™ configuration.

## Use environment for the OmniTom Elite

The OmniTom Elite is designed for use in the general hospital setting. The integrated drive system allows medical professionals to bring high quality imaging to the patient, be it in the ICU, Emergency Department, or Intraoperatively in the Operating Suite. For use in a Mobile Stroke Unit the SmartMSU option is required for proper translation in a vehicle.

## Chapter 1 Compliance and Safety Requirements

It is important that you are familiar with compliance and safety requirements to ensure you, the patient, and the systems are safe at **all** times.

---

### IEC classification and symbols



In accordance with International Safety Standard IEC 60601-1, the OmniTom Elite CT scanner is classified as Type B equipment; Class 1 equipment, internally powered equipment, and continuous connection to the supply remains in standby state and for specified loading.

Type B equipment provides an adequate degree of protection against shock, in particular regarding:

- Allowable leakage current.
- Reliability of the protective earth connection.
- In accordance with the International Safety Standard IEC 60601-1, the manufacturer is not responsible for any consequences caused by the unauthorized modification of this equipment.
- Earth leakage current.



**WARNING** Equipment is not suitable for use in the presence of a flammable anesthetic mixture with air or with oxygen or nitrous oxide.





















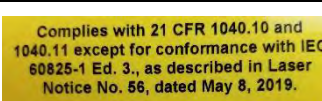





**WARNING** Equipment is not suitable for use with oxygen or oxygen-enriched atmospheres.







**Mode of operation** is a continuous connection to the supply mains in standby state and for specified loading conditions.

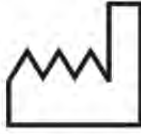

The OmniTom Elite CT scanner is patient-environment equipment.

Table 2: Applicable IEC symbols

Symbol	Description
	Alternating current
	Protective earth (ground)
	Functional Earth
	Caution: consult accompanying documents
	Caution: risk of electrical shock
	Electrostatic sensitive devices
	Type B equipment
	X-ray warning
 (InTriangle)	X-ray source assembly emitting
	Non-ionizing radiation
	Warning: laser in use
	Warning: Laser Radiation Do Not Stare Into Beam Class 2 Laser Product
	Laser Output and Standards Information Label
	Warning: FDA Laser Information

Symbol	Description
	Warning: high temperature
	Emergency switch
	Crush warning
	Foot/toe crush warning when lowering machine
	System up
	System down
	Load limit for scan board
	Temperature limits
	Keep away from rain for packaging
	Humidity limit for packaging
	Warning: battery charging
	Fuse usage
	Refer to instruction in user manual/booklet

Symbol	Description
	Legal Manufacturer Symbol
	Date of Manufacture
	Catalogue Number
	Serial Number
	Caution
	To indicate that separate collection for waste of electronic equipment
<b>Rx Only</b>	Prescription Device
	Medical Device Symbol
	CE Mark or Conformité Européenne ; number below CE represent Notified Body number

Symbol	Description
	Intertek ETL (Edison Testing Laboratories) Mark
	European Authorized Representative Symbol



**WARNING** This x-ray unit may be dangerous to patient and operator unless safe exposure factors and operating instructions are observed.

## Environmental specifications



**CAUTION** The specified environment must be constantly maintained: 24-hours a day, seven days a week.

Table 3: Operating environment

Operating	
Ambient temperature	10° C to 35° C (50° F to 95° F)
Relative humidity	20% to 85% (non-condensing)
Altitude	0-3048 m (0-10,000 ft.)
Storage	
Temperature (without batteries installed)	-20° C to 60° C (-4° F to 140° F)
Temperature (with batteries installed)	-20° C to 50° C (-4° F to 122° F)
Relative humidity	20% to 85% (non-condensing)
Powering system	
Time period prior to powering the system	24 hours

If the system is in a facility outside the noted operating temperature, it is recommended to allow the noted time for the system to acclimate to the environment.

For SmartMSU systems specifically, in extreme weather conditions, some ambulances equipped with a SmartMSU do not maintain the specified environment inside the vehicles. Temperature-sensitive components in the system might not operate optimally when using the SmartMSU outside the defined environmental specifications. When the system is outside the specified operating environment for an extended period, the system must remain powered down and kept in the recommended operating environment for 24 hours to allow the system to reacclimate before charging batteries or powering back on. The Operating Environment is 50°F-95°F (10°C-35°C) and relative humidity 20% to 85% (non-condensing)"

Considerations when preparing gantry for use:



**CAUTION** Check for obstructions before moving and system setup.



**CAUTION** Monitor scanner motion to prevent collision with surrounding environment and foreign objects.



**CAUTION** Press red **EMERGENCY STOP** button immediately in case of abnormal or unexpected motion.



**WARNING** Verify scanner is on its Translate system (fully down position) prior to positioning patient at scanner entrance.



**WARNING** Make sure all extremities are clear of the scanner while lowering or raising it.



**WARNING** Keep patient in view at all times. Ensure that the patient can be seen when the operator is near the LCD (touch screen) and **EMERGENCY STOP** button. Never leave the patient unattended when the patient is in the gantry.

NeuroLogica advises complying with local regulations and/or site recommendations as specified by the facility physicist or certified representative for the following:

- Use mobile x-ray protective-shielding devices. Technologists should be at the correct location and consider wearing personal radiation protective equipment.
- A radiation safety plan in the working-area boundaries, to include as needed, mobile x-ray protective shielding devices. Otherwise assign a larger, working area to avoid radiation to the public. Effective dose for people outside the working area should be less than 0.25mSv annually (equals to 5 uSv weekly). The air kerma rate 0.3 meters away from the working area will be smaller than 2.5 uGy/h. Have monitoring and personal dose management for occupational exposure and related public health care personnel.
- There should be a working plan before scanning. The plan should include CT condition, time, location, working area, scanning plan, and site-clearing method; clearly state the responsibilities of working, protection, and management personnel. Keep a good record of the whole process.
- Restrict the working control and monitor area. Place obvious warning signs at the control-area boundaries to prevent unauthorized personnel from entering. Installation of a working status indication light is recommended.
- In accordance with the safety plan, self-monitor during the scanning process. A certified radiation representative should monitor the working area and take measurements immediately if abnormal circumstances are detected. Additionally, this should be reported to the local environmental administrative and health departments. There should be a public notice at the working area, to include the nature of work, time, location, control area, name of the working department, person in charge of the project, contact telephone number, and radiation report telephone number.

## Site specification

Table 4: Site specification

Issue	Comment
Receiving area	Secured
Packing material and waste	Near availability of a trash receptacle for dunnage
Room dimensions for use	14ft x 14ft room with a finished, level floor; recommended the room be well lit
Power availability	120 VAC - 20 amp /240VAC – 16-amp wall outlets
Floor flatness	< 0.120 in. (3mm) over 10 in. (250mm)

**Note:** Not all beds are compatible with this system. Please contact Customer Service for assistance.

**Note:** For good image quality, the recommended practice is to keep the system free from vibration and to maintain the flatness specification noted.

Table 5: System operating parameters

Operating voltage	100-240 VAC ( $\pm 10\%$ ) (100-120 / 208-240 VAC)
Operating frequency	50Hz-60Hz ( $\pm 5\%$ )
Apparent resistance of supply mains at 120VAC	0.3 ohms
Operating current at 120VAC	16/8 amps
Heat dissipation	1672 watts

Table 6: Battery operating parameters

Operating voltage	57.5 - 83.95VDC per brick
Output current <sub>(peak)</sub>	25 amps per brick

## Hazardous substances

Table 7: Hazardous substances table

Substance/material	@ Weight/system
Lead	7.48kg (16.5lbs.)
Mercury	0kg (0lbs.)
Hexavalent chromium	0kg (0lbs.)
Polybrominated Biphenyls (PBB)	<0.45kg (<1lbs.)
Polybrominated Diphenyl Ethers (PBDE)	<0.45kg (<1lbs.)

## Part numbers and product-marking plates

Table 8: Core-system-component part numbers and product-marking plate locations

Component	Part number	Product-marking plate locations
OmniTom Elite gantry	0-NL5000-000	Near the main input plug or on the side of the system.
QA phantom	10-00011-001	On the front of the phantom.

**Note:** The applicable components making up the OmniTom Elite CT scanner is identified with the nameplate statement “This product complies with radiation performance standards, 21 CFR sub-chapter J.”

Table 9: Core-system component dimensions and weight

Component	Size (inches) (L x H x W)	Size (centimeters) (L x H x W)	Weight (lbs)	Weight (kg)
OmniTom Elite system	65.4 x 61.6 x 29.9	165.2 x 156.6 x 75.95	1700	771
With SmartMSU option	54 x 61.6 x 29.9	137.6 x 156.6 x 75.95	1700	771



Figure 1: Scanner dimensions



Figure 2: Product marking plate

## Class 1 Type B medical devices

This equipment generates, uses, and can radiate radio-frequency energy. The equipment may cause radio-frequency interference to other medical and non-medical devices and to radio communications. To provide reasonable protection against such interference, this product complies with emission limits for Class 1 medical devices as stated in EN 60601-1-2.

However, there is no guarantee that interference will not occur in a particular installation. If this equipment is found to cause interference (which can be determined - by switching the equipment on and off), the user should attempt to correct the problem using one or more of the following measures:

- Re-orient or relocate the affected device(s).
- Increase the separating space between the equipment and the affected device.
- Power the equipment from a source different from that of the affected device.
- Consult the point of purchase or the service representative for further suggestions.

NeuroLogica Corp. is not responsible for any interference caused either by the use of interconnect cables other than those recommended or by unauthorized changes or modifications to this equipment. Unauthorized changes or modifications could void the user's authority to operate the equipment.

To comply with the regulations applicable to an electromagnetic interface for a **Group 1 Class A** medical device, note the following:

- All interconnect cables to peripheral devices **must be** shielded and properly grounded.
- Use of cables not properly shielded and grounded may result in the equipment causing radio-frequency interference in violation of the European Union's Medical Device Directive and FCC regulations.



**CAUTION** Ensure there is no potentially detrimental interaction of system's irradiation with a patient's active and implantable medical devices and/or body-worn and active medical devices.



**CAUTION** Do not use devices that intrinsically transmit radio waves (such as a cellular phone, radio transceiver, mobile radio transmitter, radio-controlled toy, etc.). Use of these devices near this equipment could cause this equipment to malfunction. Keep power of these devices turned off when near this equipment.

- Medical staff in charge of this equipment are required to instruct technologists, patients, and other people who may be around this equipment to fully comply with the above regulations.

---

## Focal spot

The x-ray tube has a single focal spot with nominal dimensions of 1.0mm wide by 1.0mm long, with a range of 1.0 to 1.4mm, as defined by IEC 336-601. The spot does not move by more than  $\pm 0.2$ mm due to thermal expansion in any direction. The tube does have a positional tolerance of  $\pm 1$ mm from the end of the anode and from the window.

---

## Filtration

The x-ray tube's total filtration of the irremovable layers is 2.54mm of aluminum.

---

## Source to Detector Distance (SID)

The SID value is 596mm.

---

## Compliance statement

**Note:** All editions and years of revisions for standards noted in this chapter are static as of **Revision 18** of this *OmniTom Elite User Manual*.

The OmniTom Elite system complies with the regulatory requirements of the following:

- ISO 14971: Medical Devices – Application of Risk Assessment to Medical Devices.
- CAN/CSA C22.2 No 60601-1:14 Medical electrical equipment - Part 1: General Requirements for Basic Safety and Essential Performance.
- EN ISO 13485 Quality systems - Medical devices - Particular Requirements for the Application of Quality System.
- IEC 60601-1 Medical electrical equipment - Part 1: General Requirements for Basic Safety and Essential Performance.

- IEC 60601-1-2 Medical Electrical Equipment - Part 1-2: General Requirements for Basic Safety and Essential Performance - Collateral Standard: Electromagnetic Compatibility - Requirements and Tests.
- IEC 60601-1-3 Medical Electrical Equipment Section 1-3: General Requirements for Safety. Collateral Standard: General Requirements for Radiation Protection in Diagnostic X-ray Equipment.
- IEC 60601-1-6 Medical Electrical Equipment - Part 1-6: General Requirements for Basic Safety and Essential Performance - Collateral Standard: Usability.
- IEC 60601-2-44 Medical Electrical Equipment - Part 2-44: Particular Requirements for the Safety of X-ray Equipment for Computed Tomography.
- IEC 60825-1:2014 Safety of Laser Products - Part 1: Equipment Classification, and Requirements.
- IEC 60825-1:2007 Safety of Laser Products - Part 1: Equipment Classification, and Requirements.
- IEC 62133 Secondary Cells and Batteries Containing Alkaline or Other Non-acid Electrolytes - Safety Requirements for Portable Sealed Secondary Cells, and for Batteries Made from them, for use in Portable Applications.
- IEC 62366 Application of Usability Engineering to Medical Devices.
- IEC 62304 Medical device software – Software life cycle processes.
- JIS T0601-1: 2017 – Medical Electrical Equipment – General Requirements for Basic Safety and Essential Performance
- KS C IEC 60601-1:2013 – Medical Electrical Equipment – General Requirements for Basic Safety and Essential Performance
- AS / NZS IEC 60601.1:2015 – Medical Electrical Equipment – General Requirements for Basic Safety and Essential Performance
- NEMA XR-25 Specifies an Equipment Feature for CT Scanners to Produce Dose-related Notification and Alert Messages to Inform Operators Prior to Scanning if the Estimated Dose Would Exceed the Preset Levels.
- NEMA XR-29 Standard Attributes on CT Equipment Related to Dose Optimization and Manual.
- International Electrotechnical Commission (IEC) International Standards Organization, when applicable.
- NeuroLogica Corporation is ISO 13485:2016 and MDSAP certified.

---

## EMI/EMC terms

### Electromagnetic compatibility

**Electromagnetic Compatibility (EMC)** is the branch of electrical sciences that studies **Electromagnetic Interference (EMI)** which is the unintentional generation, propagation, and reception of electromagnetic energy with reference to the unwanted effects that such energy may induce. The goal of EMC is the correct operation, in the same electromagnetic environment, of different equipment, which use electromagnetic phenomena and the avoidance of any interference effects.

In order to achieve this, EMC pursues two different kinds of issues. Emission issues are related to the unwanted generation of electromagnetic energy, to the countermeasures that should be taken in order to reduce such generation, and to avoid the escape of any remaining energies into the external environment. Susceptibility or immunity issues, in contrast, refer to the correct operation of electrical equipment in the presence of unplanned electromagnetic disturbances.

Interference mitigation is achieved by addressing both emission and susceptibility issues, that is, quieting the sources of interference, making the coupling path between source and victim less efficient, and making the potential victim systems less vulnerable.

## Radio frequency interference

**Radio Frequency Interference (RFI)** is a type of EMI in the radio frequency spectrum that causes an unwanted disturbance that affects an electrical circuit due to electromagnetic radiation emitted from an external source. The disturbance may interrupt, obstruct, or otherwise degrade or limit the effective performance of the circuit. The source may be any object, artificial or natural, that carries rapidly changing electrical currents, such as an electrical circuit, the sun, or the northern lights.

## Susceptibility

Susceptibility is the capability of an electronic system to respond to unwanted electrical energy.

## EMI/EMC compliance

This equipment complies with IEC 60601-1-2 EMC standard for medical devices.

The OmniTom Elite system is suitable to be used in an electromagnetic environment, as per the limits and recommendations described in the tables hereafter:

- Emission compliance level and limits (Table 11).

Immunity compliance level and recommendations to maintain equipment clinical utility (Table 12, Table 13, and Table 14).

**Note:** This system complies with the above-mentioned EMC standard when used with supplied cables. If different cable lengths are required, contact a qualified service representative for advice.

Table 10: Acronyms and abbreviations

Acronym and abbreviation	Definition
<b>AEC</b>	Automatic Exposure Control
<b>CT</b>	Computed Tomography
<b>CTDI<sub>vol</sub></b>	Volume Computed Tomography Dose Index

Acronym and abbreviation	Definition
<b>CTDI<sub>w</sub></b>	Weighted average Computed Tomography Dose Index
<b>DICOM</b>	Digital Imaging Communication in Medicine
<b>DLP</b>	Dose Length Product (DLP)
<b>DHCP</b>	Dynamic Host Control Protocol
<b>EMC</b>	Electromagnetic Compatibility
<b>EMI</b>	Electromagnetic Interference
<b>FOV</b>	Field Of View
<b>HIS</b>	Hospital Information System
<b>HU</b>	Hounsfield Unit
<b>MAR</b>	Metal Artifact Reduction
<b>MIP</b>	Maximum Intensity Projection
<b>MPR</b>	Multi-Planar Reformation, sometimes referred to as Multi-Planar Reconstruction
<b>PACS</b>	Picture, Archiving, and Communication System
<b>QA</b>	Quality Assurance
<b>RIS</b>	Radiology Information System
<b>RSO</b>	Radiation Safety Officer
<b>RFI</b>	Radio Frequency Interference
<b>SCP</b>	Service Class Provider
<b>SCU</b>	Service Class User



**WARNING** Medical, electrical equipment needs special precautions regarding EMC and needs to be installed and put into service according to EMC information provided in accompanying documents.



**CAUTION** Portable and mobile RF communications equipment can affect medical electrical equipment.



**CAUTION** Do not use or stack the equipment or system with other equipment and if adjacent or stacked use is necessary, the equipment or system should be observed to verify normal operation in the configuration in which it will be used.

**Note:** The EMC tables and other guidelines included in this user manual provide information to the user essential in determining the suitability of the equipment or system for the electromagnetic environment of use, and in managing the electromagnetic environment of use; to permit the equipment or system to perform its intended use without disturbing other equipment and systems or non-medical electrical equipment.

**Note:** The EMISSIONS characteristics of this equipment make it suitable for use in industrial areas and hospitals (CISPR 11 class A). If it is used in a residential environment (for which CISPR 11 class B is normally required) this equipment might not offer adequate protection to radio-frequency communication services.

The user might need to take mitigation measures, such as relocating or re-orienting the equipment.

Table 11: Emission declaration for OmniTom Elite system

OmniTom Elite system is intended for use in the electromagnetic environment specified below. The user of the OmniTom Elite system should assure it is used in such an environment.		
Emissions test	Compliance	Electromagnetic environment guide
RF emissions CISPR 11	Group 1	The OmniTom Elite system uses RF energy only for internal function. Therefore, the RF emissions are very low and are not likely to cause any interference in nearby electronic equipment.
RF emissions CISPR 11	Class A	The OmniTom Elite system is predominantly intended for use in non-domestic environments, and not directly connected to the public mains network. The OmniTom Elite system is predominantly intended for use (for example, in hospitals) with an appropriate power supply and the recommended shielding for portable use.
Harmonic emissions, IEC 61000-3-2	Class A	
Voltage fluctuations/ flicker emissions, IEC 61000-3-3	Complies	

Table 12: EMC immunity declaration for the OmniTom Elite system

OmniTom Elite system is intended for use in the electromagnetic environment specified below. The user of the OmniTom Elite system should assure it is used in such an environment.			
Immunity test	IEC 60601-1-2 test level	Compliance level	Electromagnetic environment guidance
Electrostatic Discharge (ESD) IEC 61000-4-2	± 6 KV contact ± 8 KV air	± 6 KV contact ± 8 KV air	Floors should be wood, concrete, or ceramic tile. If floors are covered with synthetic material, the relative humidity should be at least 30%.

OmniTom Elite system is intended for use in the electromagnetic environment specified below. The user of the OmniTom Elite system should assure it is used in such an environment.			
Immunity test	IEC 60601-1-2 test level	Compliance level	Electromagnetic environment guidance
Electrical fast transient/burst IEC 61000-4-4	$\pm 2$ KV for power supply lines $\pm 1$ KV for input/output lines	$\pm 2$ KV for power supply lines $\pm 1$ KV for input/output lines	Mains power quality should be that of a typical commercial or hospital environment.
Surge IEC 61000-4-5	$\pm 1$ KV line-line $\pm 2$ KV line-ground	$\pm 1$ KV line-line $\pm 2$ KV line-ground	Mains power quality should be that of a typical commercial or hospital environment.
Voltage dips, short interruptions, and voltage variations on power supply input lines IEC 61000-4-11	>95% dip for 0.5 cycle  60% dip for 5 cycles  30% dip for 25 cycles  >95% dip for 5 seconds	>95% dip for 0.5 cycle  60% dip for 5 cycles  30% dip for 25 cycles  >95% dip for 5 seconds	Mains power quality should be that of a typical commercial or hospital environment. If the user of the OmniTom Elite system requires continued operation during power interruptions, it is recommended that the OmniTom Elite system be powered from its internal batteries.
Power frequency (50/60Hz) magnetic field IEC 61000-4-8	3 A/m	3 A/m	Power-frequency magnetic-fields should be at levels characteristic of a typical location in a typical commercial or hospital environment.

Note: The wireless receiver operates within the following bands.

- 2.412 to 2.462 GHz (11 channels)
- 5.180 to 5.240 GHz (4 channels)
- 5.260 to 5.320 GHz (4 channels)\*
- 5.500 to 5.700 GHz (8 channels, excluding 5.600 to 5.640 GHz)\*

5.745 to 5.825 GHz (5 channels)

The preferred frequency band is 5.189 to 5.240 GHz at 40MHz bandwidth.

The wireless transmitter operates within the following frequency bands and power.

802.11b:

Typ.  $26\pm 1.5$  dBm @ 1 Mbps, Typ.  $26\pm 1.5$  dBm @ 2 Mbps

Typ.  $26\pm 1.5$  dBm @ 5.5 Mbps, Typ.  $25\pm 1.5$  dBm @ 11 Mbps

802.11g:

Typ.  $23\pm 1.5$  dBm @ 6 to 24 Mbps, Typ.  $22\pm 1.5$  dBm @ 36 Mbps

Typ.  $20\pm 1.5$  dBm @ 48 Mbps, Typ.  $19\pm 1.5$  dBm @ 54 Mbps

802.11n (2.4 GHz):

Typ.  $23\pm 1.5$  dBm @ MCS0/8 20 MHz,

Typ.  $18\pm 1.5$  dBm @ MCS7/15 20 MHz

Typ.  $23\pm 1.5$  dBm @ MCS0/8 40 MHz,

Typ.  $17\pm 1.5$  dBm @ MCS7/15 40 MHz

802.11a:

Typ.  $23\pm 1.5$  dBm @ 6 to 24 Mbps, Typ.  $21\pm 1.5$  dBm @ 36 Mbps

Typ.  $20\pm 1.5$  dBm @ 48 Mbps, Typ.  $18\pm 1.5$  dBm @ 54 Mbps

802.11n (5 GHz):

Typ.  $23\pm 1.5$  dBm @ MCS0/8 20 MHz,

Typ.  $18\pm 1.5$  dBm @ MCS7/15 20 MHz

Typ.  $23\pm 1.5$  dBm @ MCS0/8 40 MHz,

Typ.  $18\pm 1.5$  dBm @ MCS7/15 40 MHz

The device includes 4 dBi gain antennas.

---

## Countermeasures against EMC related issues

Generally, it is difficult to solve issues related to EMC. It may take a variable amount of time and cost to identify issues causing interference.

General countermeasures to minimize EMI are as follows:

- Electromagnetic interference may be alleviated by positioning other equipment farther away from the source of the EMI.
- MI may be mitigated by changing relative location (installation angle) between system and other equipment.
- EEMI may be eased by changing wiring locations of power/signal cables of other equipment.
- EMI may be reduced by altering the power-supply path of other equipment.
- Electromagnetic environment specified (Table 12 and Table 13).

Table 13: EMC immunity declaration



<p>OmniTom Elite system is intended for use in the electromagnetic environment specified below. The user of the OmniTom Elite system should assure it is used in such an environment.</p>			
Immunity test	IEC 60601-1-2 test level	Compliance level	Electromagnetic environment guidance
<p>Conducted RF IEC 61000-4-6</p>	<p>3 Vrms 150kHz to 80MHz</p>	<p>V1 = 3 Vrms</p>	<p> <b>WARNING:</b> Portable and mobile RF communications equipment should be used no closer to any part of the OmniTom Elite system, including cables, than the recommended separation distance calculated from the equation appropriate for the frequency of the transmitter.</p>
<p>Radiated RF IEC 61000-4-3 (alternative method: IEC 61000-4-21)</p>	<p>3 Vrms 80MHz to 2.5GHz</p>	<p>E1 = 3 V/m</p>	$d = \left[ \frac{3.5}{V_1} \right] \sqrt{P}$ $d = \left[ \frac{3.5}{E_1} \right] \sqrt{P} \quad 80 \text{ MHz to } 800 \text{ MHz}$ $d = \left[ \frac{7}{E_1} \right] \sqrt{P} \quad 800 \text{ MHz to } 2.5 \text{ GHz}$ <p>Where P is the maximum power rating in watts and d is the recommended separation distance in meters. Field strengths from fixed transmitters, as determined by an electromagnetic site survey, should be less than the compliance levels (V1 and E1). Interference may occur in the vicinity of equipment marked with the following icon:</p> 

Table 14: Recommended separation distances

Recommended separation distances between portable and mobile RF communications equipment and the OmniTom Elite system			
OmniTom Elite system is intended for use in an electromagnetic environment in which radiated RF disturbances are controlled. The user of the OmniTom Elite system can help prevent electromagnetic interference by maintaining a minimum distance between portable and mobile RF communications equipment (transmitters) and the OmniTom Elite system as recommended below, according to the maximum output power of the transmitters.			
Rated maximum output Power (P) if transmitter Watts (W)	150kHz to 80MHz Separation distance meters <sup>1</sup>	80MHz to 800MHz Separation distance meters <sup>1</sup>	800MHz to 2.5GHz Separation distance meters <sup>1</sup>
0.01	0.12	0.12	0.23
0.1	0.38	0.38	0.73
1	1.2	1.2	2.3
10	3.8	3.8	7.3
100	12	12	23
For transmitters rated at a maximum output power not listed above, the separation distance is estimated using the equation in the corresponding column, where P is the maximum output power rating of the transmitters in Watts (W) according to the transmitter manufacturer.			
At 80MHz and 800MHz, separation distance for higher frequency range applies.			
These guidelines may not apply in all situations. Electromagnetic propagation is affected by absorption and reflection from structures, objects, and people.			
<sup>1</sup> Separation distance according to frequency of transmitter, measured in meters (m).			

Table 15: Test specifications for ENCLOSURE PORT IMMUNITY to RF wireless communications equipment

Test Frequency (MHz)	Band <sup>a)</sup>	Service <sup>a)</sup>	Modulation <sup>b)</sup>	Max Power (W)	Distance (m)	Immunity Test Level (V/m)
385	380-390	Tetra 400	Pulse Modulation <sup>b)</sup> 18Hz	1.8	0.3	27
450	430-470	GMRS 460, FRS 460	FM <sup>c)</sup> ±5kHz deviation	2	0.3	9

			1 kHz sine			
710	704-787	LTE Band 13,17	Pulse Modulation b) 217Hz	0.2	0.3	9
745						
780						
810	800-960	GSM 800/900 TETRA 800, iDEN 820, CMDA 850, LTE Band 5	Pulse Modulation b) 18Hz	2	0.3	28
870						
930						
1720	1700-1990	GSM 1800; CMDA 1900; GSM 1900; DECT; LTE Band 1, 3, 4, 25; UMTS	Pulse Modulation b) 217Hz	2	0.3	28
1845						
1970						
2450	2400-2570	Bluetooth, WLAN, 802.11 b/g/n, RFID 2450, LTE Band 7	Pulse Modulation b) 217Hz	2	0.3	28
5240	5100-5800	WLAN 802.11 a/n	Pulse Modulation b) 217Hz	0.2	0.3	9
5500						
5785						

## Use recommendations

This product complies with IEC 60601-1-2 standard for medical devices and with radio frequency emission requirements per CISPR11 Group 1 Class A standard limits. The OmniTom Elite system is predominantly intended for use in hospitals.

Do not use devices that intentionally transmit RF signals (cellular phones, transceivers, or radio-controlled products) in the vicinity of this equipment as it may cause

performance outside the published specifications. Keep the power to these types of devices turned off when near this equipment.

Adhering to the distance separation (recommended in Table 14) between 150kHz and 2.5GHz, will reduce disturbances recorded at the image level, but may not eliminate all disturbances. When installed and operated as specified herein, the system will maintain its essential performance by continuing to safely acquire controlled, radiological, x-ray exposures in a mobile radiography environment. For example, a 1W mobile phone (800MHz to 2.5GHz carrier frequency) must be 2.3 meters apart from the OmniTom Elite system (in order to avoid image interference risks).

The use of accessories, transducers, and cables, other than those specified, may result in degraded, electromagnetic compatibility of the OmniTom Elite system.

The medical staff in charge of this equipment is required to instruct technicians, patients, and other people who may be around this equipment to comply fully with the above equipment requirements.

---

## Installation recommendations

This system complies with the above-mentioned EMC standard when used with supplied cables. To minimize interference risks, the following requirements apply.

### Cable shielding and grounding

All interconnect cables to peripheral devices must be shielded and properly grounded. Use of cables not properly shielded and grounded may result in the equipment causing radio-frequency interference.

### Adjacent components and equipment

OmniTom Elite system should not be used adjacent to or stacked with other equipment; if adjacent or stacked use is necessary, the OmniTom Elite system should be tested and verified to make sure normal operation in the configuration in which it is used. Consult NeuroLogica and Facility Technical Support staff regarding device/system configurations.

### Static magnetic field limits

To avoid interference on the OmniTom Elite system, static-field limits from the surrounding environment are specified. The static field is specified as less than 1 Gauss around the unit.

## Electrostatic discharge environment and recommendations

- To reduce electrostatic-discharge interference, install a charge-dissipative floor-material to avoid electrostatic charge-buildup.
- The relative humidity must be at least 30 percent.
- The dissipative material must be connected to the system ground-reference.

---

## Facility IT-NETWORK

The OmniTom Elite system utilizes the IT-NETWORK for the customer (as applicable) to communicate with the modality worklist and for supplemental, image-storage space. As part of the installation, the applicable IT-NETWORK is reviewed to create the appropriate setup for the system. Setup is done to ensure no potential concerns arise with the system.



**CAUTION** It is possible that the IT-NETWORK connection from the system could result in previously unidentified issue(s) to the respective population. Should this occur, please contact Customer Service right away to identify, analyze, evaluate, and resolve the issue(s).



**CAUTION** It is possible that any changes to the IT-NETWORK made by the facility could introduce a new issue where Customer Service needs to be contacted to address the concern, right away.

Changes to the IT-NETWORK include – but are not limited to the following:

- Changes in network configuration
- Connection to additional items
- Disconnection to items
- Updating equipment
- Upgrading equipment.

---

## Hazard Information

Please review this material before using the system and observe basic, common-sense safety rules when operating this scanner.

## General safety considerations and statements

Review the following before using the system and observe basic, common-sense safety rules when operating the scanner:

- Become familiar with the functional hardware to help recognize serious problems.
- Do not use scanner if it appears damaged or fails.
- Wait for qualified personnel to correct any problem.

-  **WARNING** The health software is installed on a medical device and is required for its operation. In order to securely remove the software from use, the system must be decommissioned.
-  **WARNING** Modification of this equipment is not allowed.
-  **CAUTION** All non-medical electrical equipment will comply with relevant IEC and ISO safety standards.
-  **CAUTION** Federal law restricts the use of this device without a prescription by a physician.
-  **CAUTION** Always store and/or use unit in a well-ventilated area. Keep air pollution to a minimum. Keep floor clean at all times.
-  **CAUTION** Do not touch parts of non-medical electrical equipment in patient environment and patient simultaneously.
-  **CAUTION** For disposal of any material emanating from the system; follow local regulations.
-  **CAUTION** This system was designed for use by individuals trained in CT system operation. The user should be familiar with this user manual before scanning patients.
-  **CAUTION** It is the user's responsibility to make sure that after installation or subsequent modification, the system will be in compliance with the requirements of collateral standard IEC 60601-1.
-  **WARNING** Installation of this product is performed in accordance with Installation Manual (1-NL5000-059). All installation processes and personnel qualifications are outlined in that document.
-  **WARNING** Proper disposal of batteries is required to ensure compliance with environmental safety guidelines. Contact authorized NeuroLogica representative for instructions.
-  **WARNING** Observe safety-exposure factors and operating procedures to protect patient from physical harm during contact with this x-ray scanner.
-  **WARNING** Observe safety requirements to prevent excessive dose exposure to patient and/or operator.
-  **CAUTION** Improper system usage could endanger patients and/or users and void the warranty if not operated correctly.
-  **CAUTION** Should the Tablet encounter a computer related virus, contact Technical Support for assistance with removing the virus from the equipment.
-  **CAUTION** Radiation dose exposure to patients should not exceed 1Gy CTDI.



**CAUTION** For proper disposal of material at equipment's end-of-useful life, as a service to the user, NeuroLogica can dispose of the device. Please contact NeuroLogica's dealer or customer service at 1-888-564-8561.



**CAUTION** Equipment that uses only basic insulation to protect against electric shock should not be used in this system.



**CAUTION** If issues occur while obtaining patient dose report, contact Technical Support for assistance.

## Laser safety

The lasers themselves are mounted internally to the disk assembly, which spins (as prescribed by the control panel) within the system's bore. Therefore, the laser's output light will always be aimed at, and rotating within the bore itself.

## Laser parameters

**Wavelength** = 650nm

**Output Power** = 1mW



**WARNING** Complies with 21 CFR 1040.10 and 1040.11 except for conformance with IEC 60825-1 Ed. 3., as described in Laser Notice No. 56, dated May 8, 2019.



**WARNING** Viewing the laser output with certain optical instruments (for example, eye loupes, magnifiers, and microscopes) within a distance of 100mm may pose an eye hazard.



**CAUTION** Instruct the patient to close his/her eyes before activating (turning **ON**) the alignment light.



**CAUTION** Closely monitor infants and infirm patients to prevent them from accidentally staring into the beam.



**CAUTION** Class 2 laser radiation when open. **Do not stare into the beam or view directly with optical instruments.**



**CAUTION** Use of controls or adjustments or performance of procedures other than those specified herein may result in hazardous radiation exposure.



**CAUTION** The warning label (below, for "laser in use") is located on the front of the scanner cover and also inside the scanner to identify the presence of a laser.



Figure 3: Laser safety symbol

## Scanner mobility safety



**CAUTION** Due to the mobility of the system, an external interlock is not available; however, a prescribed scan can, at any time, be terminated from the scanner or the Tablet. When the user activates the scan, a 10-second, countdown-clock, scan delay (adjustable to 99 seconds) triggers. This countdown allows the user time to perform needed tasks before the scan begins.



**WARNING** To prevent involuntary movement, do not position scanner on an incline while in **Transport** mode.



**WARNING** Contact Technical Support for assistance when movement is required on an incline.



**WARNING** Do not move the system right or left if transport on an incline becomes necessary. Always keep the system in a straight motion.



**WARNING** This system shall not be transported on an incline greater than 5°.

**Note:** Be sure there are no obstacles in front of the scanner when it is being transported.



**CAUTION** Check to ensure proper clearance is provided to allow removal of patient from scanner in case of a power failure. This is accomplished by moving patient's support (after unlocking wheel-locks) away from scanner.



**CAUTION** To prevent patient entrapment or entanglement with accompanying equipment, slowly move scanner away from patient using the LCD (touch screen) while observing patient.



**CAUTION** Do not station or operate the system on an uneven floor. The flatness requirement is 3mm over a distance of 300mm.



**CAUTION** Prior to transporting the scanner, verify that power cord is unplugged from wall to avoid damage to cord and outlet.

## Floor level (even)

For proper operation, the system must be operated on an even, level, hard surface.

## Carpeting

**Do not** use the system on a carpeted floor. Poor image quality could result due to unevenness of the floor.

## Electrical safety



**WARNING** The system's external AC power cord should be checked prior to use to verify there are no exposed wires or damaged insulation/prongs. Damaged prongs could result in sparking and fire. In case of such damage, contact Customer Service immediately.



**CAUTION** Check to ensure the AC outlet is working properly before plugging in the system's AC power cord.



**WARNING** To prevent electrical shock, do not connect items that are not specified as part of the system.



**WARNING** To prevent electrical shock, do not remove the covers from the equipment. The covers protect the user and the patient from moving parts and electrical shock. Hazardous voltages are present within this equipment. The covers provide protection from radiation exposure given off from the x-ray tube. The covers also protect the equipment.



**WARNING** An electrical shock hazard: no user should replace parts. Refer to qualified service personnel for any service.



**WARNING** Always electrically isolate this equipment from the main electrical supply before cleaning and disinfecting it. This is necessary to prevent short-circuiting or possible electrical shock.



**WARNING** Never position the mobile system in a manner that prohibits access to unplugging it or prohibits pressing the EMERGENCY STOP button.



**WARNING** To minimize shock hazard, the system chassis must be connected to an electrical ground. The system is grounded through the ground conductor of the supplied, three-conductor power cord. The power cord must be plugged into a three-conductor electrical outlet receptacle. Do not alter the ground connection.



**WARNING** Avoid all contact with any electrical conductor as follows:

- Allow only people who know the proper procedures and use the proper tools to install, adjust, repair, or modify the equipment.
- Only use this equipment in rooms or areas that comply with all applicable laws (or regulations having the force of law) concerning electrical safety for this type of equipment.
- Always electrically isolate this equipment from the main electrical supply before cleaning and disinfecting it.
- The detachable cord is the disconnecting device, which is used to remove mains power from the wall socket.
- The system is internally powered.



**WARNING** For Class 1 equipment using an alternate internal source: a warning to use the alternate source if the integrity of the protective earth conductor is in doubt.



**WARNING** Do not position the system so that it is difficult to access the AC power cord.



**CAUTION** Protect the system power cord against mechanical damage.

Where the integrity of external, protective conductor in the installation or its arrangement is in doubt, equipment is operated from its internal electrical power source.

Parts of non-medical electrical equipment in the patient environment that, after removal of covers, connectors, without the use of a tool, may be contacted by the operator during routine maintenance and calibration, will operate at a voltage not exceeding 25VAC or 60VDC or peak value supplied from a source that is separated from the supply mains in accordance with one of the methods described in IEC 60601-1.



**CAUTION** To help prevent tripping hazards, use care in the arranging of any cords (for example, AC cord, Ethernet cable, etc.) when connecting to the system.



**CAUTION** To prevent damaging electrical outlet cords, check to ensure they have been removed and properly stored before transporting the scanner.



**CAUTION** All systems within the patient environment provide the same level of safety as medical equipment complying with IEC 60601-1.



**WARNING** The OmniTom Elite CT scanner contains high-voltage circuits for generating x-rays. Only trained and qualified personnel should be permitted access to the internal parts of this equipment.

## Mechanical safety



**WARNING** In case of unwanted movement or motion, press the **EMERGENCY STOP (E-STOP)** button.



**WARNING** Physically assist all patients on and off the bed and into position on the scan board. Adjust the bed to the specified height for patient loading and unloading.



**WARNING** When positioning the scanning platform, be careful when moving the patient support to avoid having it hit the scanner covers.



**WARNING** Position any lines (IVs, respirator hoses, electrical leads, etc.) attached to the patient so the lines cannot catch on the scanner during scanner travel.



**CAUTION** Prevent pinching or crushing of the patient's extremities. Keep patient's hands on the side of his/her body. Watch the patient and equipment carefully at all times during scanner movement.



**CAUTION** To prevent pinching or crushing of the operator's feet/toes, be sure extremities are not positioned under the scanner when it is being lowered from **Transport** mode to **Scan** mode.

## Radiation safety



Figure 4: Dangerous to patient and operator label



**WARNING** Improperly used x-ray equipment may result in unwanted radiation exposure. Read and understand the instructions in this user manual before attempting to operate this equipment.



**CAUTION** Use technique factors prescribed by the radiologist or diagnostician. Use a dose that produces the best diagnostic results with the least x-ray exposure.



**CAUTION** All persons authorized to use the equipment must understand the dangers from excessive x-ray exposure. NeuroLogica recommends use of protective materials and devices.



**WARNING** Everyone having anything to do with x-ray must take adequate steps to insure protection against injury.



**CAUTION** The use of this device requires its users to receive proper training in accordance with local and national laws.



**CAUTION** Never perform calibration with patients in the scanner or while personnel are present in the vicinity of the scanner.



**CAUTION** Amber indicator lights (on the top of the scanner) illuminate during x-ray exposure.



**CAUTION** Ensure that there is no potential for detrimental interaction of the system's irradiation with a patient's active implantable medical devices and/or body-worn, active, medical devices.



**CAUTION** For any questions on load factors or calculating the applicable dose, Contact NeuroLogica for service. See "Contact information" on page 22.

X-rays can only be produced during the following conditions:

- The scanner is in the down (**Scan** mode) position.
- The **Start** button is activated.
- The **Tablet** is connected.

## Fire and explosion safety



**DANGER** This equipment is not suitable for use in presence of a flammable anesthetic mixture with air or with oxygen or nitrous oxide.



**DANGER** This equipment is not suitable for use in the presence of oxygen or an oxygen-enriched atmosphere.

- Fire regulation for the type of medical area being used should be fully applied, observed, and enforced. Fire extinguishers should be provided for both electrical and non-electrical fires.
- All operators of the OmniTom Elite scanner should be fully aware of and trained in the use of fire extinguishers and the firefighting equipment, and in local fire procedures.



**WARNING** Only use extinguishers on electrical or chemical fires that are specifically labeled for those purposes. Using water or other liquids on an electrical fire can lead to fatal or other serious injury.

If it is safe to do so, attempt to disconnect the equipment from electrical and other supplies before attempting to fight a fire. This will reduce the risk of electrical shocks.

## EMERGENCY STOP button



**CAUTION** Check the **EMERGENCY-STOP (E-STOP)** button at least one time a month to ensure proper function.



**CAUTION** Every user should take a few minutes to locate the E-STOP before scanning the first patient.



**CAUTION** In case of emergencies, stop scanner movement immediately by pressing the E-STOP red push-button located on the scanner, next to the LCDs (touch screens).

## Battery system safety and information

The **System battery capacity** status icon shows an indication of battery capacity, which is identical to the indicator on the scanner. The user should always check the indicator on the scanner to verify the batteries' status.



**CAUTION** The system unit contains batteries and will always be charging when plugged into AC mains.



**CAUTION** In case of battery leakage, do not handle the batteries themselves nor continue to operate the system. Contact NeuroLogica for service. See "Contact information" on page 22.



**WARNING** Do not immerse the battery in water or seawater and keep the battery in a cool dry surrounding when it stands by.



**WARNING** Do not use or leave the battery near a heat source as fire or heater



**WARNING** Do not reverse the position and negative terminals



**WARNING** Do not discard the battery in fire or a heater.



**WARNING** Do not short-circuit the battery by directly connecting the positive and negative terminals with metal objects



**WARNING** Do not transport or store the battery together with metal objects such as hairpins, necklaces, etc.



**WARNING** Do not strike, trample, or throw the battery



**WARNING** Do not use or leave the battery at high temperature (for example, at strong direct sunlight or in a vehicle in extremely hot weather).



**WARNING** If the battery gives off an odor, generates heat, becomes discolored or deformed, or in any way appears abnormal during use, recharging or storage, immediately contact NeuroLogica for service. See “Contact information” on page 22.

## System battery capacity

The range is 0 to 100. Battery voltage and current are used to calculate the system’s battery capacity based on charging (plugged in) state.

## Run time operation

During normal run-time operation (all components, up and running), the battery capacity is calculated one time per second.

## State changes

After each periodic update, battery capacity is checked to make sure it does not fall below certain thresholds, as follows:

- Low voltage alarm state
- When the scanners battery capacity goes below 25%. It will remain in this state until the battery capacity has gone back up to 27% or higher.

## Predictive scanning

Before each scan, battery usage for that scan is predicted based on the selected load factors (for example, kV, mA, time), and is compared against the available battery charge. In the case that there is not enough charge to complete a scan, a pop-up

appears on the Tablet screen. The user can cancel the scan at that time or continue the scan, with the understanding that the scan may abort due to a low-power fault.

## Under voltage protection

When the **system battery voltage** drops below the low-voltage cutout-level while unplugged, a system power-down sequence is initiated.

## Recovering the system

Make sure the system is plugged into an operational wall outlet.

**Note:** The system will not boot up fully until the system reaches 10% charge. This can take up to 30 minutes. Full charge can take up to ninety (90) minutes.

If the system does not resume normal operation as the batteries recharge, there is likely a fault in the battery system; contact NeuroLogica for service.

## Tablet

To check the charging status of the tablet, select the Scanner Status Icon in the top, right corner to see the capacity of the battery, ranging from 0 to 100%. The Scanner Status screen also displays a lightning bolt when the tablet is plugged in and charging. This screen is only active if the tablet is connected to an operational scanner. The user should always check the screen to verify the status of the batteries.



Figure 5: Tablet battery capacity icon

**Note:** The operator panel provides a way to verify that the scanner is plugged in and charging. The blue light if solid means the batteries are fully charged. If the light is off, then the batteries are not charging. If the blue charge light is blinking the system is charging normally. If the system is not charging and is plugged into an outlet, please check if the wall power is active, to avoid permanent damage to the batteries.

The battery system is designed to be replaced by authorized and trained NeuroLogica service personnel, *only*.



**CAUTION** The Tablet will not report the proper battery capacity and status if a network connection to the scanner is not made.



**CAUTION** The system can only be charged from a correctly rated wall outlet. A rating information plate is located on the product-marking plate (lower backside panel or lower left side panel).



**CAUTION** The system should be plugged in at all times when not in **Transport** mode, being transported or in scanning use, to help maintain battery life and proper system operation. Failure to do so could result in permanent battery damage, which will require a service technician to repair.



**CAUTION** The system may not complete a scan when below 25% battery capacity while unplugged.



**CAUTION** If the system is unplugged and battery capacity drops to 0%, permanent battery damage can occur.



**CAUTION** The system can be charged only from a correctly rated wall outlet.



**CAUTION** The power cord selection must not be less than 220v/16A, made of 2.08mm (diameter) copper wire in accordance with local power supply cable standards.

**Note:** Medical grade power cords should be used at all times.

## Battery component for the base power distribution assembly

**Note:** All battery safety warning and charging methods are similar to the direction respectively noted for the battery system in the above section: Battery system safety and information of this document.



**WARNING** Proper disposal of batteries is required to ensure compliance with environmental safety guidelines. Contact authorized NeuroLogica representative for instructions.

## Maintenance and service



**WARNING** Equipment maintenance of non-medical electrical equipment should not be performed in the patient environment.



**WARNING** Maintenance checks and all service must be performed by NeuroLogica trained technicians. Service personnel use Service manual (1-NL5000-062) to effectively perform needed service and preventive maintenance and inspection on the system. See “Contact information” on page 22 for NeuroLogica’s contact information.



**WARNING** The only calibration performed by the user on this system is called **daily calibration** and is described in detail later in this user manual. All other calibration needs that arise must be performed by trained

technicians at NeuroLogica Corp. See “Contact information” on page 22 for NeuroLogica’s contact information.



**CAUTION** Service personnel must complete training at NeuroLogica Corp. for the system and its accessories prior to conducting any service activities.

Users are not to perform service or maintenance on the system at any time. This includes battery maintenance.

**Note:** NeuroLogica recommends that a six-month preventive maintenance be conducted by NeuroLogica’s service personnel/trained facility bioengineer.

NeuroLogica recommends a semi-annual service contract.

Instructions for replacing serviceable parts are identified in the Service Manual (1-NL5000-062).

---

## Cleaning the system

Keep the equipment clean. Remove body fluids to prevent health risk and damage to internal parts.

**Note:** NeuroLogica recommends a solution of  $\geq 99\%$  pure Isopropyl Alcohol (IPA) to sufficiently clean the equipment.

When the system is between uses, NeuroLogica recommends keeping it clean as described below. This will help remove body fluids to prevent health risk and damage to internal parts.



**WARNING** Do not use flammable or potentially explosive disinfecting sprays, since resultant vapor could ignite, causing personal injury and/or damage to the equipment.



**WARNING** In order to prevent short-circuiting or possible electrical shock, do not spray cleaning agents or spill liquid cleaning agents directly onto the machine.



**WARNING** Always electrically isolate this equipment from the main electrical supply before cleaning and disinfecting it to prevent short-circuiting or possible electrical shock.



**CAUTION** The unit surfaces may be cleaned with a soft cloth and the recommended solution or a similar mild non-abrasive cleaning solution. General purpose liquid disinfectant may also be used as necessary. Apply the cleaning solution to the cloth, not directly to the unit.

---

## Cybersecurity



- WARNING** Upon detection of a cybersecurity threat to the system or **Tablet**, do the following:
- Immediately contact Technical Support.
  - Discontinue use of system (enabling the **EMERGENCY-STOP** if needed).
  - Remove any Ethernet and/or wireless connection that has been made with the facilities' IT-network.

Continued use of the system can occur after Technical Support has assessed the situation and provided the “go-ahead” to do so.

**Note:** NeuroLogica Corp. recommends the customer facility utilize an IT-network that provides sufficient means of cybersecurity control to help maintain the requirements of HIPAA.

---

## Contraindication(s)

There are no contraindications associated with CT x-ray scanning.

---

## Personnel privileges and terminology

### Qualified operator

The operator (for example, technologist, radiologist, and other professionals that are authorized to handle x-ray equipment) as determined by the healthcare facility and assigned by a user with administrative privileges – who by their education, certification, experience, and training, are sufficiently qualified to competently perform clinical scans on the particular model of CT system which they are to use. See “Understanding the types of users” on page 88 for a description of the types of users.

### Operator of record

The operator of record is an operator or health care professional currently logged onto the CT system with a unique username and password identifier.

### Scanning privileges

Scanning privileges are granted to a qualified operator, assigned by a user with administrative privileges, to conduct clinical scans on the particular model CT system which they are to use. This privilege level allows use of all clinical protocols to properly scan the patient.

## Protocol privileges

Protocol privileges are granted to a qualified healthcare professional (for example, radiologist, technologist, physicist), as determined by the healthcare facility and assigned to users with administrative privileges, who by their education, certification, experience, and training, is sufficiently qualified to competently save clinical protocols (either new or modified) on the particular model CT system they are working on. A healthcare professional with protocol privileges does not necessarily have to have scanning privileges on the particular CT system.

## Administrator privileges

Administrator privileges are granted to qualified healthcare professionals (for example, radiologist, technologist, physicist, department administrator, etc.) as determined by the healthcare facility who by their education, certification, experience, and training, is sufficiently qualified to competently assign, maintain, and oversee the assignments of personnel to scanning privileges and/or protocol privileges on the particular CT system which they administer. In addition, qualified healthcare professionals are authorized and qualified to pull system logs associated with this standard for Quality Assurance review. Healthcare professionals with administrative privileges do not necessarily have to have scanning privileges or protocol privileges on the particular CT system.

## Clinical operation

CT system operation that involves scanning live humans and/or creating or editing protocols intended for use on live humans.

## Clinical scanning

CT system operation that involves scanning of live humans.

## Clinical protocol

A protocol on the system intended for use on live humans.

## Kernel

The kernel is defined as the reconstruction algorithm or mathematical equation used for convolution of the attenuation profiles and reconstruction of the CT images. The choice of the kernel determines the noise level and the contrast resolution of the reconstructed images.

## Chapter 2 System Overview

To understand general aspects of the system, this chapter gives a brief, initial overview of the parts of the system. For example, it provides basic skills for powering on and off the scanner, familiarizing yourself with the LCD (touch screen) when the scanner is on, as well as how to locate and use **E-STOP**.

After you are familiar with basic parts of the system, you can learn how to use the scanner and **Tablet**.

**Note:** *It is advised* to power up the OmniTom Elite system hardware first, to allow time for the scanner to warm up, then power up the tablet once the scanner power-up has completed.

The OmniTom Elite CT system lets you scan patients in a room or ward, an **Intensive Care Unit (ICU)**, an **Emergency Room (ER)**, a medical satellite facility, an **Operating Room (OR)**, and a private office or clinic.

---

### OmniTom Elite system

The OmniTom Elite is a 16-slice, portable, battery-operated CT scanner and software system with **Axial**, **Helical** and **Dynamic** capabilities. It has sixteen rows of 0.625mm detectors in the Z axis; with each rotation the scanner covers 10mm of anatomy. Total coverage is 500mm.

The OmniTom Elite core system consists of the scanner, scan board, bed adapter, QA phantom, interface cables, lead shielding curtains, and the OmniTom Elite Tablet.

Consider the following:

- The Scanner and Tablet communicate using a wireless connection.
- The OmniTom Elite Tablet is a computer with custom software that allows the user to employ pre-defined system protocols or devise unique protocols for performing that user's patient studies. The viewing portion of the OmniTom Elite Tablet allows the user to view images in more detail and includes tools to help facilitate diagnosis by a physician.

**Note:** Although the tablet does have a high-resolution display, it is not certified as a diagnostic viewing station.

- The scanner uses a minimum slice-thickness: 0.625mm and a maximum coverage: 500mm. The maximum scout length is 500mm.
- Scan boards are headboards that support the patient's head and neck while the patient undergoes a scan or study.
- Specially designed platforms are also available for scanning neo-nates and small pediatric patients who cannot be scanned in their own beds.

---

## The LCD touch screen

The **Liquid Crystal Display (LCD)** is a touch screen that is located on both sides of the scanner. The touch screen displays patient information, machine-positioning buttons for a scan, and scanner-status information.

The touch screen contains three tabs that show different information, actions, options, and buttons which include: the **Acquisition**, **Positioning**, and **Transport** tabs. To make a tab active, and see what actions you can perform from the tab's panel, press the tab. The tabs are described later in this user manual. See "Overview of the scanner's LCD touch screen" on page 65.



Figure 6: Acquisition, positioning, and transport tabs on the LCD touch screen

---

## The shielding curtains

The shielding curtains decrease radiation to those around the patient.

To learn more about the US and European findings regarding the scatter radiation measurements with open curtains, no curtains, or closed curtains, see "Scatter radiation" on page 154. To learn how to use the shielding curtains, see "Using the curtains for shielding" on page 85.

---

## The tablet

The **Tablet** is an accompanying part of each scanner; it is the control unit that operates all respective functions of the system.

The **Tablet** is connected wirelessly to the scanner. All basic information related to the Tablet (for example, operating distance, warnings and cautions, connectivity, functionality, etc.) appears in Chapter 4 Basic Tablet Operations.



Figure 7: OmniTom Elite tablet

Table 16: Tablet display dimensions

Display	
Screen	12.3" PixelSense™ Display
Resolution	2736 X 1824 (267 PPI)
Aspect Ratio	3:2
Touch	10-point multi-touch

**Note:** Although the tablet does have a high-resolution display, it is not certified as a diagnostic viewing station.



**CAUTION** Do not connect or use equipment beyond what is specified by NeuroLogica Corp.; this practice may lead to a reduced level of system safety.

The recommended distances, provided in Figure 8, relate *only* to distances specified by IEC 60601-1 and **do not** relate to specific distances required for ionizing radiation and/or stray radiation protection for operators and bystanders.

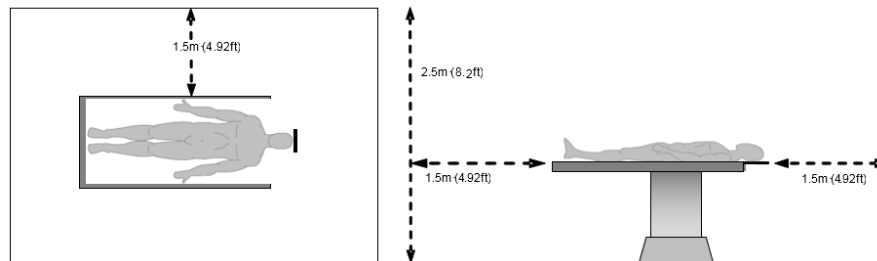

Figure 8: Tablet safe distance location (two views)

## The silhouette scan board and universal transfer board

A scan board is supplied with the system. The silhouette scan board is always used with an adapter; the universal transfer board should always be used with mattress stiffeners.

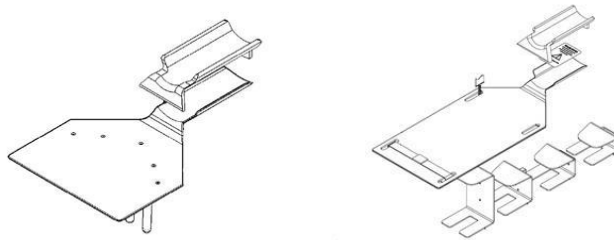

Figure 9: Silhouette scan board and universal transfer board

---

## Parts that potentially come into contact with the patient

While you use the system, be aware that the patient may come into contact with the following parts:

- The OmniTom Elite system, especially the painted, external surfaces of the system's scanner cover.
- Silhouette scan board
- Bed Adapter
- Patient Safety Straps
- Universal Transfer Board
- Pediatric and Neonate Scan Platforms.

## Chapter 3 Basic Scanner Operations

Basic scanner skills include powering on and off the scanner, learning how to use and navigate the LCD touch screen, and how to use **E-STOP**.

Scanning basics you should know before you scan a patient include how your system should be set up, how to position the scanner and the patient before the scan, and how to perform a scan using the **Tablet**.

---

### Powering on and off the OmniTom Elite system

The OmniTom Elite can be powered on and off with the power button on either side of the scanner. Press and release the power button to turn the scanner on. After pressing the power button allow time for the scanner to power up. To power off the OmniTom Elite press and hold the power button for approximately 5-10 seconds until the light ring around the power button blinks. The LCD will display a shutdown message which must be confirmed by tapping **OK**.

**Note:** The system will perform a Drive Bar Calibration upon power up. Additional information regarding the Drive Bar Calibration is discussed on page 69.



**CAUTION** Do not hang, drape, lean, or otherwise have any objects in contact with the **Drive Bar** while the scanner is powering up. Doing so can cause an erroneous calibration of the driving subsystem producing erratic driving behavior.

When powering on and off the system, consider the following:

- Make sure the scanner is properly plugged in, whenever possible; be sure the outlet(s) provide the required power.
- Plugging the electrical cord into the wall charges the batteries; the batteries are the power source that allows the scanner to operate.
- When plugging in the scanner, make sure the cable lays flat on the floor to ensure the safety of hospital personnel. In addition, make sure that the floor behind the scanner is free of any obstructions or debris that could interfere with the Translate system during scanning.

**Note:** NeuroLogica recommends the scanner be restarted weekly.

When powering off the scanner, wait at least 30 seconds before turning the scanner back on.

---

### Overview of the scanner's LCD touch screen

The LCD touch screen appears on both sides of the scanner. The touch screen lets you set up and activate a scan.

## LCD tabs and icons

The LCD screen contains three tabs: **Acquisition**, **Positioning**, and **Transport**. To make a tab active, press the tab with your finger.



Figure 10: Acquisition tab











Figure 11: Positioning tab







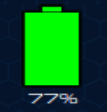





Figure 12: Transport tab

Each tab contains buttons, icons, text boxes, and status indicators to perform actions.

Table 17: Icons on acquisition, positioning, and transport tabs and actions

Icon	Description
	<p>Scanner Relative Position – Displayed on Acquisition and Positioning tabs.</p>
	<p>Laser – Displayed on Acquisition and Positioning tabs.</p>
	<p>Zero Reference position – Displayed on Acquisition and Positioning tabs.</p>
	<p>Raise scanner – Displayed only on Transport tab.</p>
	<p>All Movement – When selected will be highlighted in orange as seen in bottom picture. Scanner will move in all directions. – Displayed only on Transport tab.</p>
	<p>Lateral Lock – When selected will be highlighted in orange as seen in bottom picture. Scanner will only move or ‘strafe’ in the lateral direction. – Displayed only on Transport tab.</p>
	<p>Forward Lock – When selected will be highlighted in orange as seen in bottom picture. Scanner will only move forward or backward. – Displayed only on Transport tab.</p>
	<p>Alignment Camera – When selected, activates a camera on the back of the scanner which identifies a QR code located on the bed adapter and automatically aligns the scanner to the patient’s head on the scan board. – Displayed only on Transport tab.</p>
	<p>Lower Scanner – Displayed only on Positioning tab.</p>

Icon	Description
	Translate toward patient – Displayed only on Positioning tab.
	Translate away from patient – Displayed only on Positioning tab.
	Lock LCD Screen – Displayed on Acquisition, Positioning and Transport tabs.
	Scan – Only displayed after Patient Registration, Protocol Selection and pressing 'Begin' to initiate a scan.
	Cancel – Only displayed after Patient Registration, Protocol Selection and pressing 'Begin' to initiate a scan.
	Air freshness level – Identifies the air calibration status. – Displayed on Acquisition, Positioning and Transport tabs.
	System State Orb – Identifies the system's current state. – Displayed on Acquisition, Positioning and Transport tabs.
	Tube Heat Capacity indicates the remaining tube-capacity percentage available. – Displayed on Acquisition, Positioning and Transport tabs.
	Battery Capacity indicates the remaining battery percentage available. – Displayed on Acquisition, Positioning and Transport tabs.
	Battery Capacity showing 80V percentage (left) and 400V percentage (right). – Displayed on Acquisition, Positioning and Transport tabs. *This icon will only be seen when the difference between the two percentages is greater than 5 percent
	Hospital Network Connectivity – Displayed on Acquisition, Positioning and Transport tabs.
	Collision Sensors Enabled – Displayed only on Transport tab.
	Collision Sensors Disabled – Displayed only on Transport tab.

Icon	Description
	<p>Mute Audible Alerts – Disables the audible alerts from the collision sensors. – Displayed only on Transport tab.</p>
	<p>Disable Collision Sensors – Disables all Collision Sensors, as shown in bottom picture. When this mode is activated the system speed is reduced to approximately 35% of full speed in the forward direction. – Displayed only on Transport tab.</p>
	<p>Radiation Icon Identifies X-ray as on or off. – Displayed on Acquisition, Positioning and Transport tabs.</p>
	<p>Emergency Stop (E-Stop) – Displayed on Acquisition, Positioning and Transport tabs.</p>
	<p>Remote Support– When enabled, as seen in bottom picture, allows a NeuroLogica technical support representative to troubleshoot the system remotely. – Displayed on Acquisition, Positioning and Transport tabs.</p>
	<p>Engineering Screen – Displayed on Acquisition, Positioning and Transport tabs.</p>

## Patient information

The patient information that appears on the touch screen is there to help you confirm that the correct patient information was selected and will appear on the scan you perform. To learn more about how to enter patient information, see “Registering the patient” on page 161.

## Drive bar calibration for transport

Upon power up, the system will perform a required **drive bar** calibration. The OmniTom Elite LCD displays the following screen during the start-up sequence:



Figure 13: Initial screen when drive bar calibration begins

If the **Drive Bar Calibration** fails on the first attempt, the **LCD** will display the following screen to remind the user not to touch the drive bar during calibration:



Figure 14: Retry calibration screen

If the **Drive Bar Calibration** fails again, the **LCD** will display the following screen and Customer Service should be contacted:

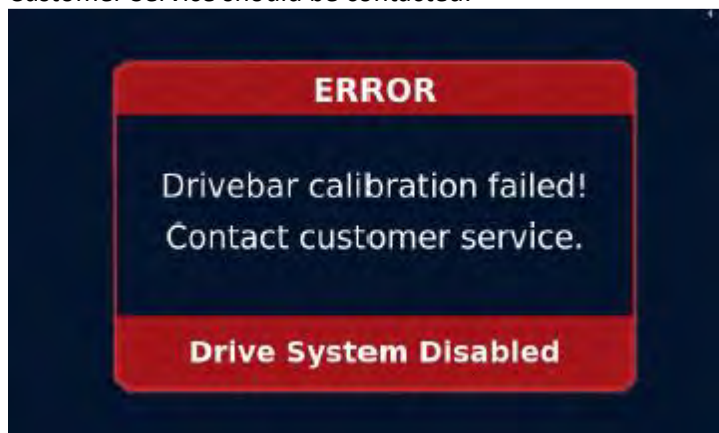

Figure 15: Drive bar calibration failed



**CAUTION** Do not hang, drape, lean, or otherwise have any objects in contact with the **Drive Bar** while the scanner is powering up. Doing so can cause an erroneous calibration of the driving subsystem producing erratic driving behavior.

## Moving the scanner for transport

To move the scanner, the scanner must be powered on and in Transport mode. The **DOWN** icons are located on both sides of the scanner on the LCD screen on the Positioning tab. The **UP** icon is located on the LCD screen on the side with the **drive bar** on the Transport tab. To set the scanner in **Transport** mode, go to the side of the scanner with the drive bar and follow the procedure below.



**CAUTION** Before transporting the scanner, verify that the Ethernet cable (if wired to PACS) is unplugged from the scanner to avoid damage to cable and receptacle. Verify that the power cable is unplugged from the wall to avoid damage to the cord and outlet.



**CAUTION** When transporting the scanner, it is recommended that two trained staff members be in control of the system to avoid any potential collisions.

1. Select the **Transport tab** on the LCD screen.



Figure 16: Active transport tab on LCD

2. Press and hold **UP arrow** to raise the scanner for transport until the **scanner reaches** the transport state. You will know you are in Transport Mode when:
  - The **Mood Ring** on the front of the scanner alternates flashing light blue and dark blue.
  - The **System Status Orb** is light blue.
  - The **Up** arrow is greyed out.
  - The **LCD** opposite the **Drive Bar** side displays “**Transport Mode**”.
  - The **Entering Drive View** pop-up box will appear.

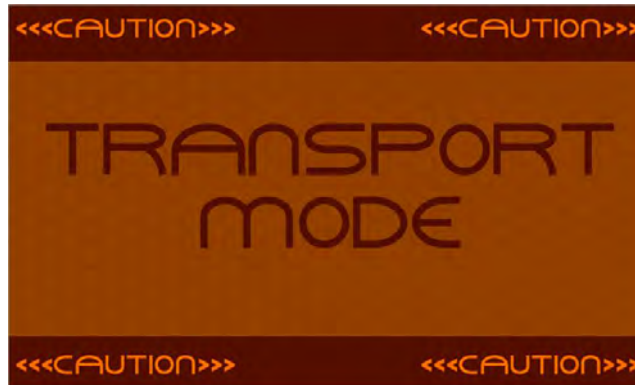

Figure 17: Transport mode

**Note:** The **drive bar** is located on the right side of the scanner and can transport in lateral, diagonal, and 360-degree movements.

The **drive bar** is equipped with an **enable bar**. The **enable bar** is a darker material located on front of **drive bar**. While holding the **drive bar**, squeeze the **enable bar** to activate the system to move (transport). If you let go of the **enable bar**, the scanner stops.

3. Once you are in **Transport Mode**, use the Drive Bar to maneuver the scanner to the patient's location. The following points explain how to hold the **drive bar** to move it forward, backward, lateral (left and right), diagonal:
  - Push forward with both hands on the **drive bar** and use equal pressure on the **enable bar** to move the scanner forward. You can also use the **Forward Lock** icon on the LCD screen to force the system to only move in the forward direction.
  - Pull back with both hands on the **drive bar** and use equal pressure on the **enable bar** to move the scanner in reverse.
  - To perform a left lateral movement, select the **Lateral Lock** icon on the LCD screen, squeeze the **enable bar** and tilt the drive bar to the left.
  - To perform a right lateral movement, select the **Lateral Lock** icon on the LCD screen, squeeze the **enable bar** and tilt the drive bar to the right.
  - Squeeze the **enable bar** and apply pressure to either the right or left side of the **drive bar** to travel diagonally in that direction.

## Drive Bar Motions for Moving Your OmniTom

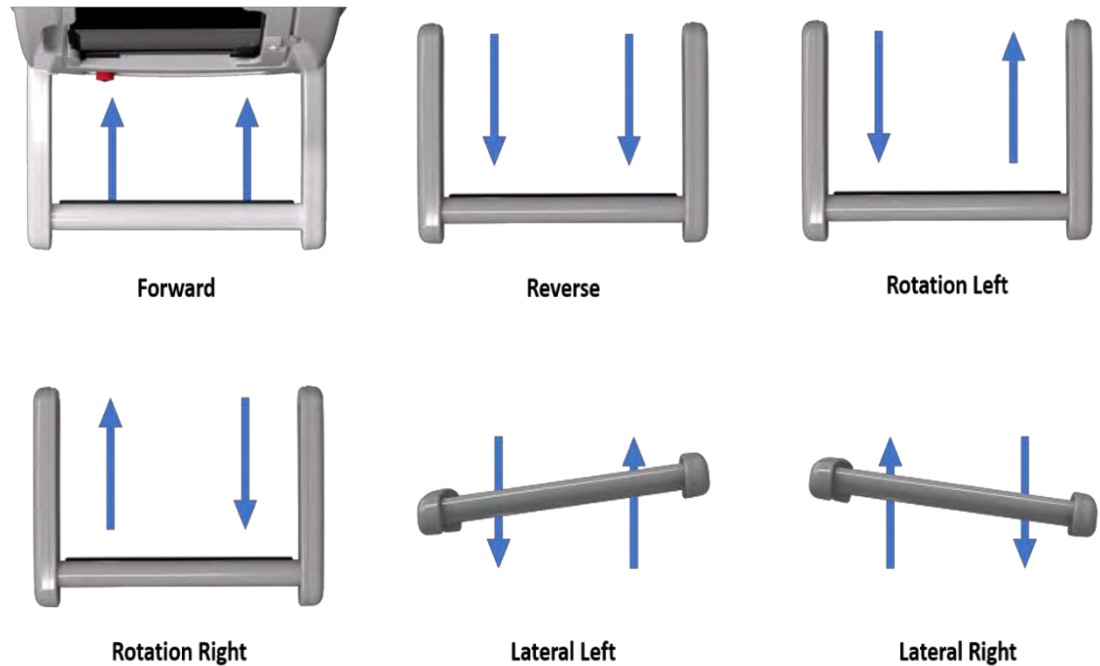

Figure 18: Drive bar motions

**Note:** A three-point driving technique is required to turn in smaller spaces (for example, narrow corridors).

**WARNING** If a loss of control is encountered while moving the system, release the **enable bar** to stop **ALL** movement.

## Using collision avoidance sensors

The scanner has **Collision avoidance sensors** that will alarm when in close proximity of an object when in **Transport** mode.

The **collision avoidance sensors** warn the user visually and audibly of upcoming obstacles, allowing the user to avoid incidents.

To ensure the Collision avoidance sensors are enabled:

- Put the Scanner in **Transport** mode.
- Select the **Transport Tab** on the LCD.
- The **collision avoidance sensors** will be illuminated when enabled.



Figure 19: Enabled collision avoidance sensors

When coming in close proximity with a large object, an audible alarm will sound, and the **collision avoidance sensors** will visually change from green to red on the LCD.

The scanner will also decrease the speed of transport and gradually stop the scanner from continuing to go forward if an obstacle is in the way.

To disable the **collision avoidance sensors**:

- Select the **Disable Collision Sensors** Icon, located on the **Transport** Tab on the **LCD**.



Figure 20: Disable collision sensor icon

You can also mute the audible alarm without disabling the **Collision Avoidance Sensors**.

To mute the **Audible Alerts**:

- Select the **Mute Audible Alerts** Icon, located on the **Transport** tab on the LCD.



Figure 21: Mute audible alerts icon

## Transporting with drive view

The scanner has an optional Drive View camera mounted on the front of the scanner which connects to the tablet to allow you to see what is in front of the scanner while driving.



Figure 22: Optional drive view camera

To enable **Drive View** the scanner must be in Transport mode.

1. Select **System**.



Figure 23: System icon

2. Select **System Settings**.



Figure 24: System settings icon

3. In System Settings select **Drive View**.



Figure 25: System settings

Once enabled the tablet will display a forward-looking view as demonstrated below:



Figure 26: Drive view

You can use the **CLOSE** option on the top right corner of the screen to disable the Drive View on the tablet.

**Drive View** can also automatically be enabled when the scanner is raised from Scan Mode into **Transport** mode. When the scanner is fully raised, the **Entering Drive View** pop-up box will appear on the tablet. Select **Enter** to allow the camera to connect to the tablet.



Figure 27: Entering drive view pop-up



**WARNING** When transporting, use Drive View and the Collision Sensors as guides to avoid hitting objects.



**WARNING** When using Drive View the camera will not show the sides of the scanner, only what is directly in front of the system. Care should be taken to avoid collisions with objects on the sides of the scanner when going through doorways or tight spaces.

## Transporting with mood ring lights

The scanner has a **Mood Ring Light** on the front of the gantry that can be disabled during **Transport** and **Scan** Modes by the operator.



Figure 28: Front of OmniTom Elite with mood ring light enabled

To disable the **Mood Ring Light**, tap the **System Status Orb** located on the LCD in the upper, right corner.

To enable, tap the **System Status Orb** again.



Figure 29: Mood ring light enable/disable feature

---

## Positioning the scanner before a scan

1. Select the **Positioning** tab on either side of the scanner on the LCD.



Figure 30: Active positioning tab on LCD

2. Press and hold the **DOWN** arrow until it lowers the scanner to **Scan Mode**. You will know you are in **Scan Mode** when:
  - The **System Status Orb** changes to the blue **IDLE** state.
  - The **Mood Ring** on the front of the scanner is also in the blue **IDLE** state.
  - The **DOWN** arrow greys out when the scanner is completely lowered into **Scan Mode**.
3. Use the positioning **LEFT** and **RIGHT** arrows to align the patient and bed with the scanner, ensuring the patient is in the center of the **Field Of View (FOV)**.
4. Align the patient bed with scanner opening to prevent a collision with patient, patient support and/or any life supporting devices prior to scanning.

**Note:** Be sure the floor is clear of debris or anything that can cause interference with the scanner's translate wheels.



**CAUTION** Ensure there is adequate clearance for the scanner to move the prescribed distance during the scout and/or scan.

5. Make sure the patient's bed is locked.



**CAUTION** Make sure to lock the patient bed or scan table to prevent it from moving during the scan.

6. Adjust the bed height so that the patient is centered within the bore.

## Positioning the patient



**WARNING** Prior to scanning, properly position the patient to ensure that extremities, hair, life support equipment, and any other in proximity of the scanner have sufficient clearance to prevent patient injury with the scanner itself and/or when used with accessories/options.



**WARNING** Ensure the patient support is properly positioned (height and alignment) to prevent injury during scanning.



**WARNING** Make sure the foot pedal brake on the patient support/bed is engaged to prevent it from moving during the scan.



**WARNING** *Never* raise or lower the scanner when a patient is positioned in the system's bore. *Always* move the scanner away from the patient support *before* raising or lowering the system itself.



**CAUTION** The following-instructions for patient positioning should be performed in accordance with NeuroLogica Corp.'s clinical training.

**Note:** To determine where personnel should stand during a scan, consult with the hospital physicist. NeuroLogica recommends a distance of 8-10 feet.

1. Attach bed adapter to the bed.



Figure 31: Bed adapter without posts insertion

2. Attach the silhouette scan board to the bed adapter by inserting the scan board into the adapter block.



Figure 32: Bed adapter with T-square

3. Tighten the Bed Adapter to the scan board by turning the T-square handle until two (2) clicks are heard.



Figure 33: Attaching the scan board with bed adapter to patient's bed

4. Position the patient until the patient's head rests on the pad of the scan board as shown below.



Figure 34: Positioning the patient on the bed

5. Position the patient in front of the scanner opening. The patient's shoulders should rest flat against the face of the device.
  - Make sure the patient is centered in the scanner bore.



Figure 35: Ensuring placement of patient's neck directly under laser light

6. Lock the gurney or bed wheels before proceeding with scan.

## Using alignment camera

The OmniTom Elite scanner includes an automatic Alignment Camera that can be used to position the scanner so that it is centered on the bed adapter and scan board.

To enable the Alignment Camera:

1. Attach the Bed Adapter and Scan Board to the patient's bed.
2. Drive the scanner near the patient's bed so the alignment camera on the front of the scanner can 'see' the Alignment markers attached to the silhouette scan board.



Figure 36: OmniTom Elite alignment camera

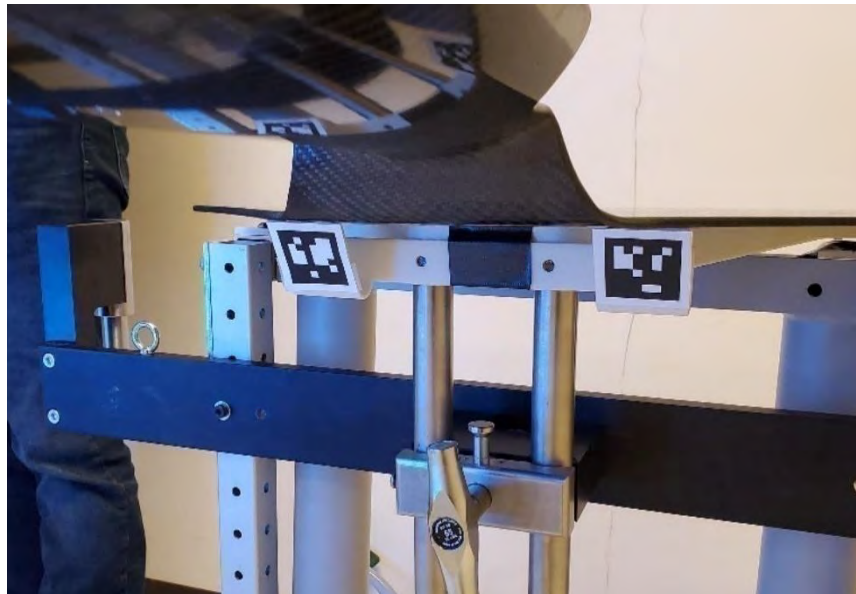

Figure 37: QR code alignment indicators

**Note:** The scanner must be within the envelope shown below in order for the alignment camera to find the QR code on the scan board.

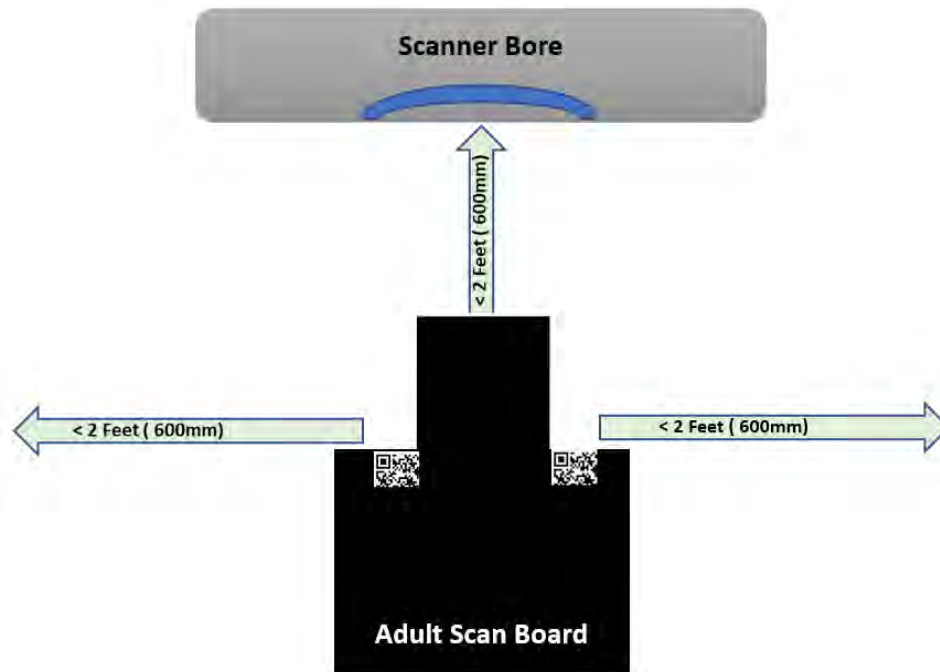

Figure 38: Adult scan board

3. While the scanner is in Transport mode, and near the patient’s bed, select the **Align** icon on the LCD.



Figure 39: Align icon

4. Once selected the camera will look for the Alignment markers on the scan board.



Figure 40: Looking for alignment markers

5. If the alignment markers are found, the following screen will appear.



Figure 41: Alignment found

6. If the markers are not found there may be something blocking the camera view or the scanner is not within the proper envelope, and the following screen will appear. If the markers are not found, check for proper placement of the scanner in the alignment envelope and obstructions blocking the camera view and select **RETRY**.



Figure 42: Alignment not found

7. When the Alignment markers are found select **Move** which will show the following:



Figure 43: Alignment moving

8. When the scanner is in the proper location the LCD will indicate Alignment is complete.



Figure 44: Alignment complete

9. You can now move the patient onto the scan board and into position for your scan.

**Note:** The OmniTom Elite with the SmartMSU option does not include the following items:

- Drive Bar or Drive System
- Drive View Camera
- Collision Avoidance Sensors
- Alignment Camera



**WARNING** Always align scanner to scan board before positioning the patient on the scan board.



**WARNING** The Alignment camera can only be used on the adult silhouette scan board. It is not currently available with the neo-nate or pediatric platform.



**WARNING** Please note that the collision sensors are not active when using the Alignment camera.



**WARNING** If the scanner moves unexpectedly while aligning, press the E-stop to halt all motion.

## Positioning the scanner using the laser light

The scanner provides a laser light to guide you to properly position the patient. The lasers indicate the center of the scan or Transverse plane, the mid-Sagittal plane, and the vertical height or Coronal plane. The laser light is centered on the actual x-ray beam at all times. For multi-slice protocols, this means that the laser light will indicate the middle position of all simultaneous scans being acquired. The accuracy of the position of the laser plane, with respect to the scan plane, is +/- 2mm.

## To activate the laser light on the touch screen

1. Press the **Laser** button on the LCD screen.

2. The laser will automatically shut off, 30 seconds after pressing the **Laser** button. See the precautions regarding the laser in “Laser safety” on page 49.
3. Consider the following:
  - If the patient is conscious, request the patient remain still with eyes closed throughout the entire scan.
  - If the patient is unconscious, secure the patient.
  - Follow the appropriate facility guidelines when scanning unconscious patients if the patient’s eyes remain open.

---

## Using the curtains for shielding

Using shielding curtains is recommended when performing equipment calibrations and patient scans, to ensure maximum efficiency and patient safety.

1. Pull up the back curtain ensuring that the curtains lie flat against the back of the scanner.
2. Check to ensure that the patient is properly positioned and comfortable.
3. Position the front curtains as close to the patient as possible to minimize the space between them.

**Note:** For calibrations, the curtains should be completely closed against the front of the scanner.

The (shielding) front curtains minimum thickness is 0.5mm, the rear curtain is 0.25mm.

4. Before scanning the patient, check to ensure that nothing interferes with the patient’s life support or other external medical devices.

## Operating the E-STOP button

1. Press the **E-STOP** button to perform the following:
  - Stop the system (if it loses control).
  - Stop all system motion and x-ray.
  - Remove power to the gantry drives and x-ray system.
  - If the OmniTom Elite system starts to move unexpectedly.
2. Make sure to resolve the situation.

**Note:** When **E-STOP** is activated, the moving gantry may overrun by less than 10mm.

## Restoring the system from E-STOP

If you have pressed the **E-STOP** button to stop the system, follow these steps to restore the system using **E-STOP**.

1. Make sure any hazard is removed.

2. Twist the E-STOP button clockwise until the button pops out to restore the system.

## Rebooting the system

If your scanner needs to be rebooted press the power button for 5 seconds or until the button begins to flash, then release the button. The scanner will display a prompt asking if you would like to power down. Press 'OK' to initiate the Power down sequence.

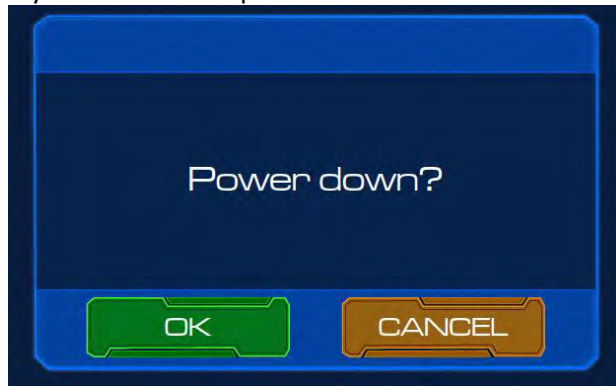

Figure 45: Power down pop-up

To restart the scanner, press the power button once. Allow a few minutes for the scanner to restart.

You will know your scanner is fully powered on when the **Mood Ring** and **System Status Orbs** change from grey (Powerup) to Idle Blue (**Scan Mode**) or alternates flashing blue (**Transport Mode**), depending on which mode the scanner was left in before rebooting.

---

## Remote support feature

The Remote Support feature allows a NeuroLogica technical support representative to troubleshoot the system remotely, perform system updates, and transfer files from the system for use in diagnosing issues. When enabled, Remote Support allows NeuroLogica personnel to take remote control of the system while you observe.

### Enabling remote support

1. Select the **Enable Remote Support** icon on the LCD.



Figure 46: Enable remote support

2. Select **OK** on the **Enable Remote Support Prompt**.

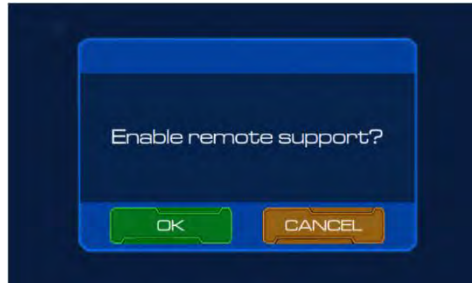

Figure 47: Enable remote support prompt

3. When the remote support session is completed, select the **Disable Remote Support** icon on the LCD.



Figure 48: Disable remote support

4. Confirm that you want to end the Remote Support Session on the **Disable Remote Support Prompt**.

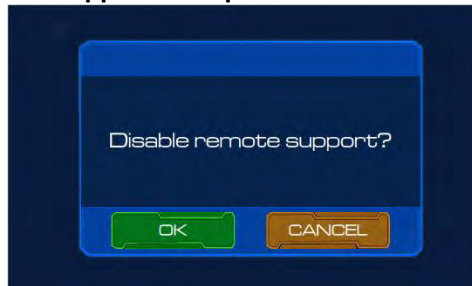

Figure 49: Disable remote support prompt

## Chapter 4 Basic Tablet Operations

Basic Tablet information includes understanding the different kinds of user access, learning how to power on and off the Tablet, getting familiar with the Tablet screen, menus, and tabs.

**Note:** *It is advised* to power up the OmniTom Elite system hardware first, to allow time for the scanner to warm up, then power up the tablet once the scanner power-up has completed.

### Understanding the types of users

There are three **User Levels** available on the Tablet: administrator, limited operator, and restricted operator. Usernames and passwords can be created for individual users, and specific User Levels can be assigned to each user. The following define the access levels for each User Level:

<b>Administrator</b>	Full access to the system and its configuration. Can create protocols, user names and passwords, as well as access all functions of the system.
<b>Limited</b>	Modified access to the system. Users with Limited access can modify protocols during scanning but cannot create and save protocols; has no access to system configuration.
<b>Restricted</b>	Users with Restricted access can scan with the system but are unable to make any changes to protocol parameters while scanning, they also have no access to system configuration.

### Powering on the tablet

1. After the scanner has completed its power-up sequence.
2. Press the **Power on** button on the Tablet.  
The Tablet will boot up and the **Login** panel appears.



Figure 50: Login panel

**Note:** NeuroLogica recommends the tablet be restarted daily.

## Logging in to the tablet

To gain access to the Tablet application, you must provide the system with credentials. These credentials consist of a **user identification (ID)** and **password**. Make sure you have a valid user ID and password before you log into the system.

**Note:** If you do not have a valid user ID and password, ask your supervisor or administrator for one.

1. Select your **User ID** from the dropdown under 'Select'
2. Click in the **Password** field and type your password in the field. Passwords are case sensitive.
3. Select the **Tap to Login** icon.



Figure 51: Tap to login prompt

If the user ID and/or password are invalid, a prompt appears denying access. Following the prompt, you are able to retry logging in with the correct credentials.



Figure 52: Access denied prompt

**Note:** You have a limited number of login attempts before the system locks the account. An administrator can unlock the account.

4. When the user ID and password are verified, you are logged into the system.
5. The Tablet software appears with the **Registration** tab active.

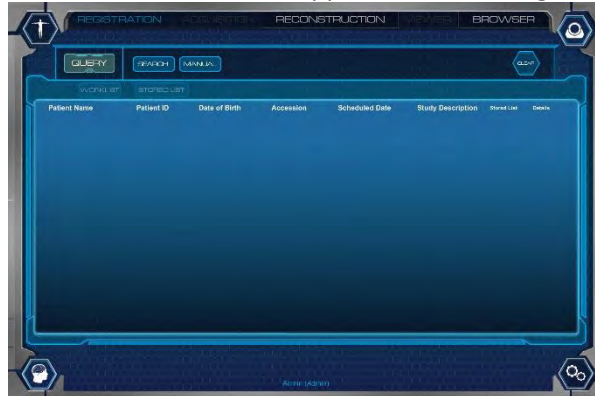

Figure 53: Registration tab

---

## Locking the tablet with the LCD

Lock the tablet to guard your work while you are away from the OmniTom Elite. It is important to lock out unwanted users even if you are away for only a short period of time.

When you lock the scanner, it will automatically lock the tablet. Although both the tablet and scanner will remain on, no one can access the tablet without your username and password.

The **Lock button** located on the LCD indicates whether your system is in lock or unlocked mode.

In addition, you can:

- Log off the tablet
- Enable the privacy screen.

**Note:** The tablet will auto lock after 15 minutes of inactivity and will require the user to input their username and password to unlock.

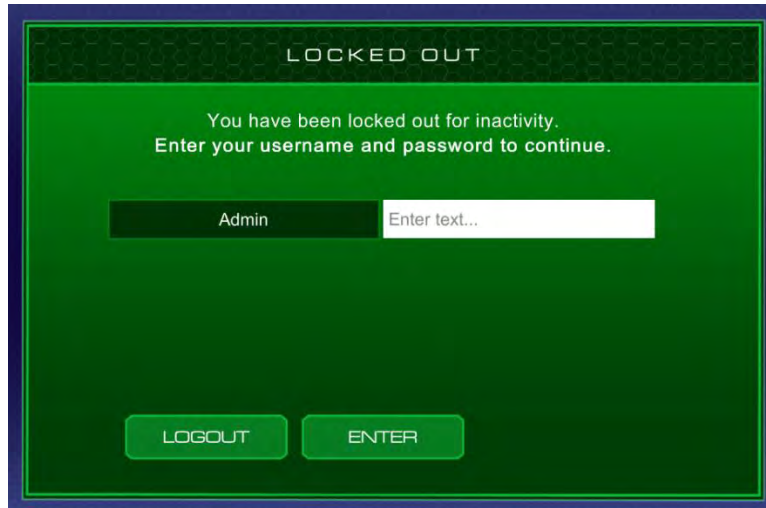

Figure 54: Automatic lock out screen

Press the **Lock** button located at bottom of the LCD.



Figure 55: System lock button

To unlock, input **3644** and press **enter** on the LCD keypad and both the scanner, and the tablet will unlock.



Figure 56: Login screen on LCD

---

## Logging off the tablet

1. Select the **System Icon**.



Figure 57: System icon

2. Select the **Logout Icon**.



Figure 58: Logout icon

3. A prompt will display asking to **Confirm** or **Cancel** the logout.



Figure 59: Confirm logout prompt

4. Select **Confirm** to logout.

---

## Powering off the tablet

1. Select the **System Icon**.



Figure 60: System icon

2. Select the **Shutdown Icon**.



Figure 61: Shutdown icon

3. A prompt will display asking to **Confirm** or **Cancel** the shutdown.



Figure 62: Confirm shutdown prompt

4. Select **Confirm** to shut down.

## Enabling the privacy screen on the tablet

1. Select the **System** Icon.



Figure 63: System icon

2. Select the **Privacy Screen** Icon.



Figure 64: System screen

The **Privacy Screen** will appear.

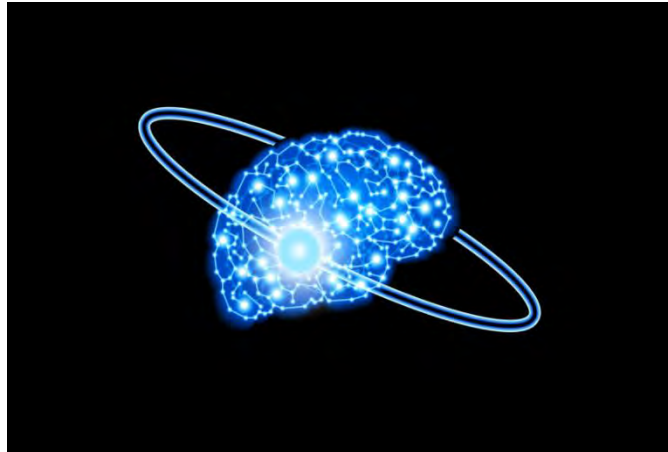





Figure 65: Privacy screen

3. To leave the **Privacy Screen**, tap below the NeuroLogica Brain Logo, and then above the NeuroLogica Brain Logo.

## Navigating around the tablet’s main screen

The Tablet screen shows similar information, regardless of the screen elements change when you perform different actions. These constant screen elements are as follows:

Table 18: Constant screen elements

Constant Screen Elements	Element	Element description
	<b>Patient Registered Icon</b>	Appears in the top left corner of the screen and when tapped displays the currently registered patient’s information.
	<b>Protocol Selected Icon</b>	Appears in the bottom left corner of the screen and when tapped displays the current active protocol parameters.
	<b>System Icon</b>	Appears in the bottom right corner of the screen and when tapped displays scanner configurations and calibrations.

	<p><b>Scanner Status Icon</b></p>	<p>Appears in the top right corner of the screen and when tapped displays status information for both the scanner and Tablet.</p>
---	-----------------------------------	---

## Getting to know the scanner status screen

The **Scanner Status** screen appears once the **Scanner Status Icon** is selected. The status screen gives you a quick view of the current system status. The following identifies the **Scanner Status** screen:

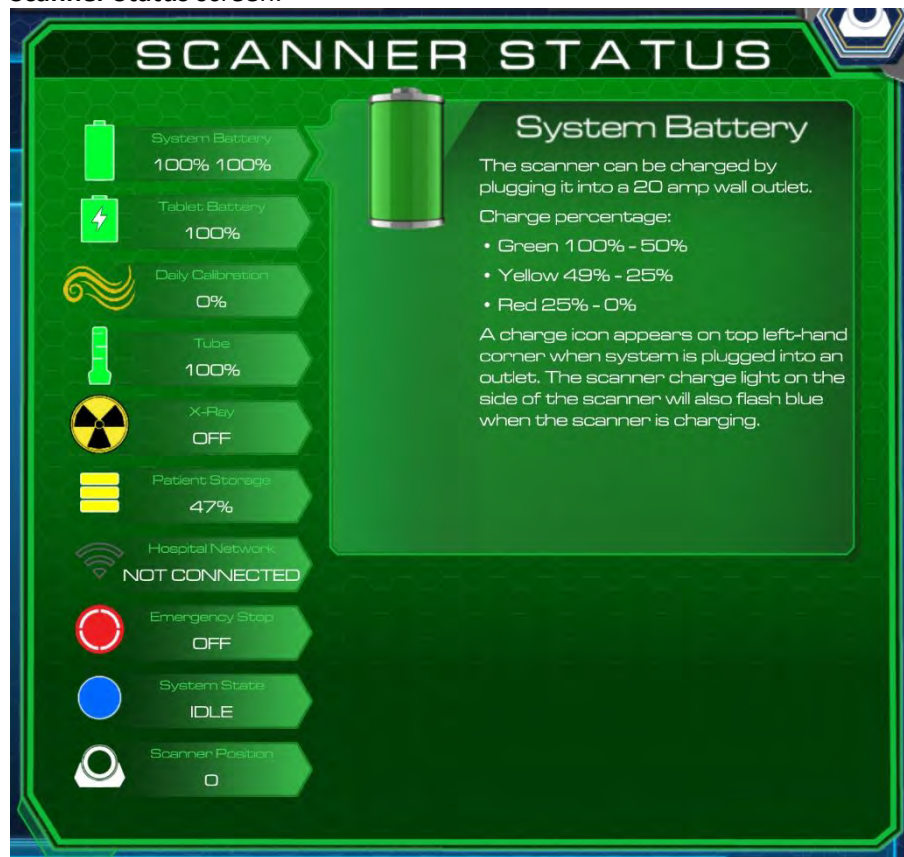

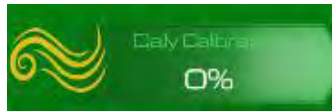
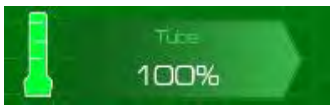



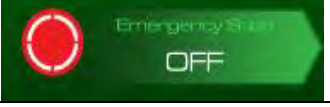

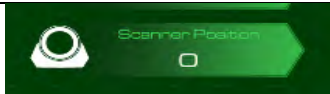

Figure 66: Scanner status screen

Table 19: Status bar identification

Status bar icon	Status bar icon name	Status description
	<b>System battery capacity status</b>	<p>Indicates the remaining scanner battery percentage available. The capacity values are color coded as follows:</p> <ul style="list-style-type: none"> <li>Green 100% - 51%</li> <li>Yellow 50% - 25%</li> <li>Red 24% - 0%</li> </ul>
	<b>Tablet battery capacity status</b>	<p>Indicates the remaining tablet battery percentage available. The capacity values are color coded as follows:</p> <ul style="list-style-type: none"> <li>Green 100% - 21%</li> <li>Yellow 20% - 11%</li> <li>Red 10% - 0%</li> </ul> <p>You will be prompted to plug the Tablet into an outlet to charge if the battery capacity is low; a scan cannot complete when the battery capacity is 10% (red) or lower.</p> <p>When the Tablet reaches the red capacity range it will shut down. A message appears informing the operator that the tablet will shut down due to a low battery.</p> <p>The lightning bolt icon signifies that the tablet is currently charging and goes away when unplugged.</p>
	<b>Daily Calibration status</b>	<p>Indicates the air freshness status; It is recommended that an air calibration be performed:</p> <ul style="list-style-type: none"> <li>• Every six (6) hours.</li> <li>• When the air freshness status falls below 50%.</li> <li>• If the scanner is moved to an area with a dramatic change in humidity and or temperature.</li> </ul> <p>The calibration status values are color coded as follows:</p> <ul style="list-style-type: none"> <li>Green 100% - 51%</li> <li>Yellow 50% - 25%</li> <li>Orange 24% - 0%</li> </ul> <p>After calibration it returns to 100%.</p>

Status bar icon	Status bar icon name	Status description
	<b>System tube heat capacity status</b>	Indicates the remaining tube-capacity percentage available. The capacity values are color coded as follows: Green 100% - 51% Yellow 50% - 15% Red 14% - 0%
	<b>Radiation status</b>	Identifies x-ray as on or off. The icon changes from a gray/black icon (when x-ray is off) to an animated (rotating) yellow/black icon when x-ray is on.
	<b>Image storage space status</b>	Indicates the available disk space on the system for image storage. The available space values are color coded as follows: Green 100% - 51% Yellow 50% - 20% Red 19% - 0%
 	<b>Wireless signal indicator</b>	Indicates the scanner's connection to the Hospital Network.
	<b>System E-STOP status</b>	Identifies when <b>E-STOP</b> is engaged. The icon will flash when <b>E-STOP</b> is pressed.
	<b>System state</b>	Identifies the system's current state. The orb changes color depending on the state the system is in. In addition, the mood ring located on the front of the scanner changes color to reflect the system's state. See Table 20, for a list of the different orb colors and system states they identify.
	<b>Scanner position</b>	Identifies the system's current position relative to its zero reference.

## System status orbs and mood ring lights











The system changes states as it performs different actions. The following table indicates what state the system is in and the colored orb that correlates to that state.

In addition, the mood ring light located on the front of the scanner also correlates to the state the system is in.



Figure 67: Mood ring light

Table 20: System state orbs and corresponding mood ring light colors

Orb	Color	State
	<b>Dark gray</b>	The system is powering up.
	<b>Light gray</b>	The system is powering down.
	<b>Dark purple</b>	The system is busy.
	<b>Blue</b>	The system is idle.
	<b>Light Blue</b>	The system is in transport mode.
	<b>Green</b>	The system is ready to perform a scan.
	<b>White</b>	The system is performing an air calibration.
	<b>Yellow</b>	The system is preparing.
	<b>Amber</b>	The system is scanning.
	<b>Pink</b>	The system is not ready.
	<b>Red</b>	The system is in fault.





## Getting to know the system screen







The **System Screen** appears once the **System Icon** is selected. The **System Screen** contains options that can execute various commands from the Tablet and contains system configurations.



Figure 68: System screen

Table 21: System options

System bar icon	System bar icon name	Status description
	<b>Daily Calibration</b>	Executes Daily Calibration.
	<b>Quality Assurance</b>	Executes Quality Assurance Test.
	<b>PACS Queue</b>	Displays status of studies being archived to PACS.
	<b>Protocol Manager</b>	Allows user with <b>Administrator</b> rights to create, modify or delete protocols.

System bar icon	System bar icon name	Status description
	<b>About</b>	Display's Software Version Information.
	<b>Shutdown</b>	Shutdown Tablet
	<b>Logout</b>	Logs user off
	<b>Privacy Screen</b>	Allows you to disable access to the tablet by covering it with the NeuroLogica Brain Logo.
	<b>Audio</b>	Turns sound on or off.
	<b>System Settings</b>	Contains System Configurations. See Chapter 5 System Settings for System Configuration options.

## Getting to know the protocol screen

The **Protocol Screen** is available after a patient has been registered, the protocol has been selected and the **Protocol Selected Icon** is selected. The **Protocol Screen** contains the following information: protocol parameters, dose, and scan time.

- The **Protocol Screen** can be used to double check parameters before making an exposure.
- In case you need to make changes to your protocol before scanning, close the **Protocol Screen** by deselecting the **Protocol Selected Icon**. Then **Cancel** from the **Acquisition Tab** or **Cancel** from the LCD.

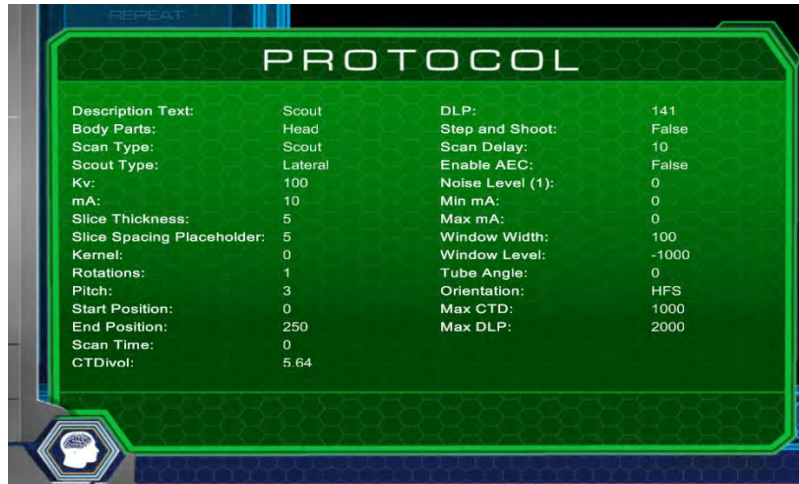

Figure 69: Protocol screen

## Getting to know the patient screen

The **Patient Screen** is available once a patient has been registered and after the **Patient Registered Icon** is selected. The **Patient Screen** displays patient demographics: ID, Accession, Study Date and Time, Date of Birth, and Sex.

- The **Patient Screen** is where **Finalize** and **Edit** are located.
- To finalize a study, select the **Finalize** button.



Figure 70: Patient screen

**Note:** A **Dose Report** will be generated upon selecting **Finalize**.

## The tablet tabs

To perform a patient examination, you will use the following five tabs on the Tablet:



Figure 71: Tablet tabs to perform a patient examination



The tabs include active tabs which will be blue if they are selected or white if they are active but not selected, and inactive tabs which will be gray. The active tabs are **Registration**, **Reconstruction**, and **Browser**. The **Acquisition** and **Viewer** tabs require additional steps to be performed before they become active. The following actions are available in each tab:

<b>Registration</b>	Allows you to register a patient either manually or from the hospital's database sites.
<b>Acquisition</b>	Allows you to select a protocol and perform the examination. This tab is inactive until a patient is registered.
<b>Reconstruction</b>	Allows you to manipulate raw data in different parameters and settings after your scan is completed.
<b>Viewer</b>	Allows you to view patient images. This tab is inactive until a study is loaded from the Browser.
<b>Browser</b>	Allows you to view, manipulate, and archive scans already performed.

In the following chapters, you will learn how to perform necessary steps to conduct a patient examination and learn how to manipulate and store the data you acquire.

## Tablet buttons

Table 22: Registration tab buttons and functions

Tablet button	Action
	Searches the <b>HIS/RIS</b> server for scheduled patients. The population of patients could take several minutes to appear, depending on the number of patient entries found from the HIS/RIS query.
	Searches queried patient entries for specific information.
	Allows you to manually enter a new patient but does not include Patient ID information.















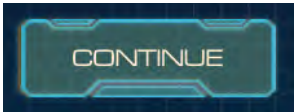

Tablet button	Action
	Clears search information entered when using the Search function.
	Displays HIS/RIS query results.
	Allows you to select patient(s) from query results and move them into the <b>Stored Results</b> list. All Manually entered patient information will default to this list.
	Allows you to manually enter a new patient including the Patient ID information.
	Registers the selected patient and then takes you to the <b>Acquisition</b> tab to select a protocol to be used for scanning.
	Found under the <b>Patient Registered Icon</b> and allows you to complete the examination. Finalizing the Exam completes all protocols, builds dose SR and images, and re-opens the <b>Registration</b> tab.

Table 23: Acquisition tab buttons and functions

Tablet button	Action
	After protocol selection, authorizes the scanner to move to the next step.
	Pauses the current exposure within an Axial Scan. This is a toggle button with the <b>Resume</b> button.
	Resumes a paused series of scans within an Axial Scan. This is a toggle button with the <b>Pause</b> button.

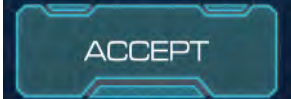
Tablet button	Action
	Repeats the last scan that was performed.
	Manually initiates x-ray exposure when using the optional Step & Shoot feature.
	Disables <b>Initiate Exposure</b> and scans remainder of planned axial scans when using the optional Step & Shoot feature.
	Used to stop a Dynamic CTA scan and move to the Helical CTA acquisition when using Bolus Tracking and the threshold in the ROI is not crossed.
	Used to accept protocol selection for exam.
	Used to begin a scan or series of scans after accepting the protocol.
	Cancels the current scan within a protocol.
	Allows user to modify existing protocol selected in exam or choose a new protocol.

## Chapter 5 System Settings

### System settings overview

A user with Administrative privileges must set up the OmniTom Elite system configurations for other users (limited and restricted operators). System configuration, overall, is how the OmniTom Elite scanner is set up to meet site-specific needs. Most windows contain self-explanatory instructions and refer to elements that are known to the administrative user with radiological education and training. Additionally, brief instructions are provided to aid in completing those sections with more detail.





Configuration includes setting up user permissions (or access privileges) to manage other users, as well as servers, what is available through settings, presets, and other preferences for the use of the system at a site. Many system configurations are permissible to the administrator, *only*. While other configurations are permissible to users without administrative access.







**Note:** You must have administrative access privileges and be logged in as an administrator to access this area in the application.

Incorrect changes to the system configuration may make the system inoperative.

The following table shows the **System Configuration** options that appear when you click the **System Icon** (from the bottom right corner of the screen), and then select one of the system options below. The table provides a brief description of these options.

Table 24: System configuration settings

Icon	Icon Name	Description
	<b>Manage Users</b>	Allows the administrator to create and edit user accounts and permissions.
	<b>Audit Trail Viewer</b>	Allows the administrator to view and log all changes as well as actions in the system, which include logins, patient registrations, and series updates.
	<b>Dose Configuration</b>	Allows the administrator to set up dose notifications, dose alerts, and configure dose limits for specific scans.
	<b>Privacy Screen</b>	Allows the user to activate the privacy screen on the tablet to hide patient information.

Icon	Icon Name	Description
	<b>Recon Presets</b>	Allows the administrator to define and customize reconstruction presets.
	<b>Recon Groups</b>	Allows the administrator to define and customize reconstruction groups.
	<b>MPR Presets</b>	Allows the administrator to define and customize MPR presets.
	<b>PACS Configuration</b>	Allows the administrator to select a different Picture, Archiving, and Communication System (PACS) server to Archive studies.
	<b>Window Presets</b>	Allows the administrator to set window width and window levels.
	<b>SMPTE</b>	Allows the user to view the SMPTE Medical Diagnostic Imaging Test Pattern.
	<b>Drive View</b>	Opens the drive camera view on the tablet when in transport mode.

## Setting user accounts

The **Administrator**, *only*, can update another user's account, add a new user, delete a user, and lock or unlock a user's access.

1. Select **System**. The **System** screen appears.



Figure 72: System icon

2. Select **System Settings**. The system settings screen appears.



Figure 73: System Settings icon

3. Select **Manage Users**. The Manage Users dialog box appears.



Figure 74: Manager Users icon



Figure 75: Manage Users dialog box

4. For the Username field, enter the user ID name.
5. For the User Level field, enter one of the following user levels:

<b>Administrator</b>	Full access permission (rights) to the system and its configuration. Can create protocols, user names and passwords, and all functions of the system.
<b>Limited operator</b>	Modified access permission (rights); can modify protocols during system use but cannot create and save protocols; has no access to system configuration.
<b>Restricted operator</b>	No access to creating or deleting protocols; has no access to system configuration.

6. For the Password field, enter the user’s password.

**Note:** The password must contain 8 to 12 characters, and must include one number, a lower-case letter, a special character, and an uppercase letter.

7. Select the Save button. The user is added to the list.
8. Press the up and down scroll bar to reorder the user list, if desired.

## Deleting a user

**Note:** The NeuroLogica administrator account cannot be deleted.

1. Select **System**. The **System** screen appears.



Figure 76: System icon

2. Select **System Settings**. The system settings screen appears.



Figure 77: System Settings icon

3. Select **Manage Users**. The Manage Users dialog box appears.

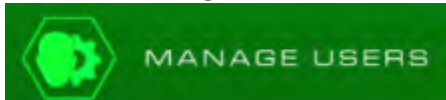

Figure 78: Manager Users icon



Figure 79: Manage Users dialog box

3. Select the user to delete from the list of users.
4. Press the **Delete** button.  
The following message will display:

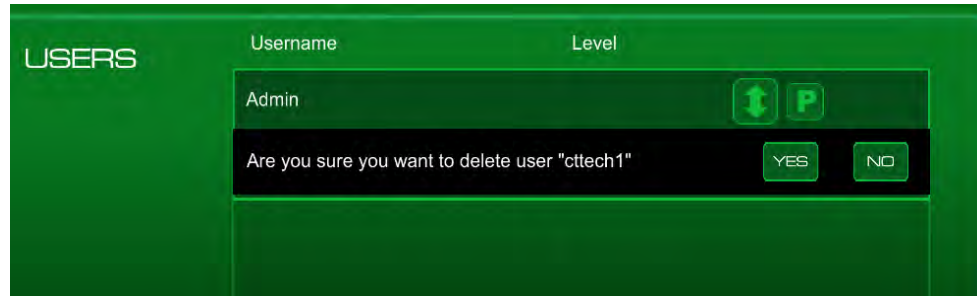

Figure 80: Delete pop up

5. Select **Yes** to delete and **No** to keep user account.
6. Select the **Close** button to exit.

## Applying dose configuration

**Note:** You must have administrative access privileges and be logged in as an administrator to access this area in the application.

Incorrect changes to the system configuration may make the system inoperative.

**Note:** You can check the **Audit Trail** to review the audit log that details what dose limit was removed, by whom, and the date and time it took place.

**Dose Configuration** consists of both Dose Notifications and Dose Alerts (defined as System Limits in OmniTom Elite System Settings).

<b>Dose Notification</b>	Notifies the user when the planned CTDI <sub>vol</sub> and/or DLP value of a single series will exceed the value defined value set in each protocol.
<b>Dose Alert (System Limit)</b>	Notifies the user when the planned CTDI <sub>vol</sub> and/or DLP value from the combination of all planned series will exceed the defined value set in <b>System Settings</b> . Dose Alerts represent a value which would be well above an institution’s established CTDI/DLP range for the given examination and warrant a more stringent review and consideration before proceeding.

## Setting dose notifications

Dose Notifications are set in Protocol Manager on a series-by-series basis. Every series in a protocol can have its own notification value. Use the following steps to edit **User** protocols to define the Dose Notification value for each series. Protocols that begin with “**NL**” are NeuroLogica reference protocols and cannot be edited within Protocol Manager using the below steps, see the **Editing Dose Notifications on NL Protocols** below.

1. Select **System**. The **System** screen appears.



Figure 81: System icon

2. Select **Protocol Manager**. The **Protocol Manager** screen appears.



Figure 82: Protocol manager icon

3. Select either **Adult** or **Pediatric**.



Figure 83: Adult or pediatric selection

4. Select the icon corresponding to the appropriate body part.

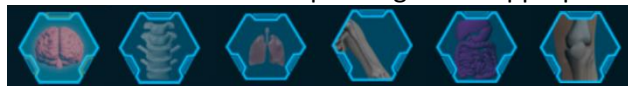

Figure 84: Body part selection

5. Select the protocol you want to add Dose Notifications to.



Figure 85: Protocol selection

6. Select **Edit** to open the protocol.

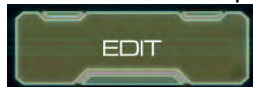

Figure 86: Edit icon

7. Select the appropriate series. In this case we are going to add a notification value to the Axial series.



Figure 87: Series selection

8. Select the dropdown menu in the **Max DLP** or **Max CTDI<sub>vol</sub>** fields

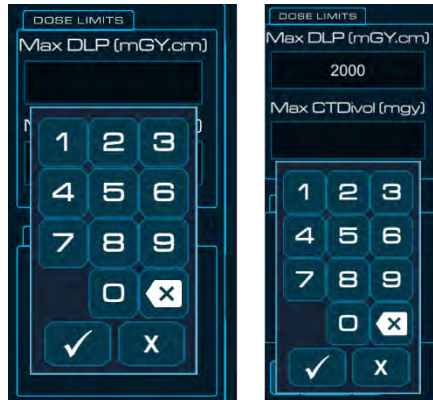

Figure 88: Max field selection

9. Enter the desired **Maximum CTDI** or **DLP** value
10. Select the **Checkmark** to save the updated value(s)
11. Select **Update**



Figure 89: Update icon

12. Select **Save**



Figure 90: Save icon

13. Continue Editing protocols or select **Close** to exit protocol manager.



Figure 91: Close button

If when using a protocol that has a Dose Notification turned on, the CTDI or DLP of the planned scan exceeds the Notification value, a Dose Notification message will be displayed on the tablet.

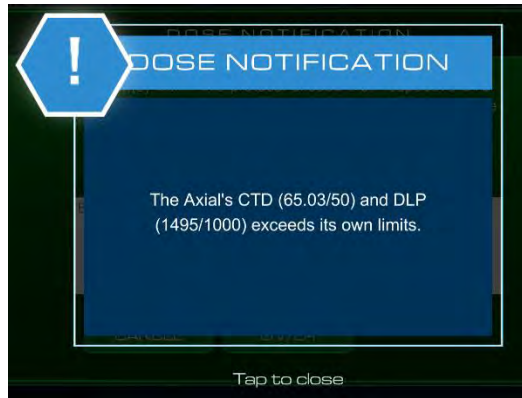

Figure 92: Dose notification message

When you 'Tap to close' the above screen the following message box will appear, asking you to enter a Diagnostic Reason for exceeding the set Dose Notification value.

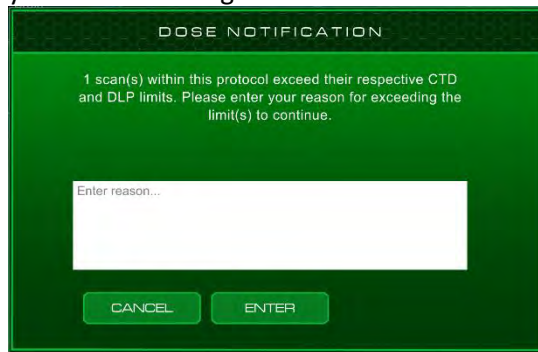

Figure 93: Diagnostic reason dialog box

You can either enter a reason and select Enter or select Cancel and modify the protocol parameters to reduce the CTDI or DLP below the Dose Notification Limits.

## Editing dose notifications on NL protocols

The NeuroLogica (NL) Reference Protocols installed on the scanner come with default Dose Notification values set at 1000 mGy CTDIvol and 2000 mGy cm DLP values. To modify those values, you must use the Dose Configuration feature found in the System Settings.

1. Select **System**. The **System** screen appears.



Figure 94: System icon

2. Select **System Settings**. The **System Settings** screen appears.



Figure 95: System setting icon

3. Select **Dose Configuration**.



Figure 96: Dose configuration icon

4. The **Dose Configuration** dialog box appears.

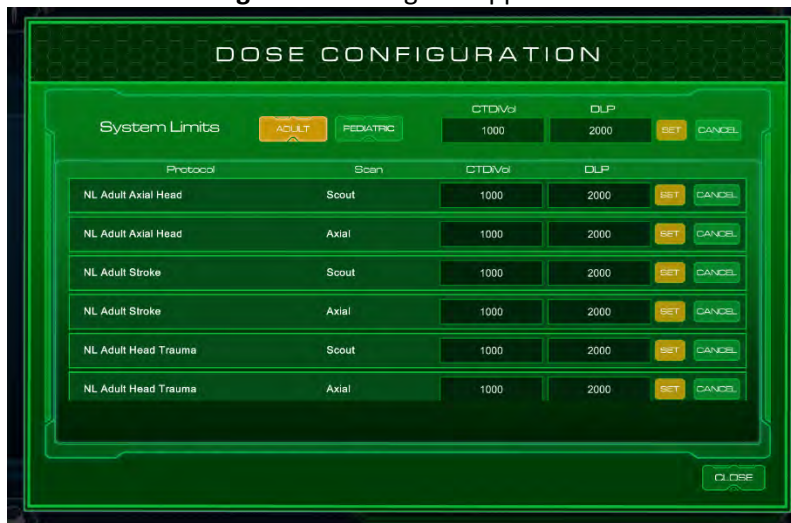

Figure 97: Dose configuration dialog box

5. Select the NL Protocol Series you want to modify.
6. Enter the **CTDIvol (mGy)** value in the text box using the dropdown menu and select the Checkmark to save the value.
7. Enter the **DLP (mGy.cm)** value in the text box using the dropdown menu and select the Checkmark to save the value.



Figure 98: Entering mGy and mGy.cm values

8. Select **Set** to save the new values.
9. Repeat steps 5 through 8 for any other protocol series you wish to modify.
10. When finished select **Close** to exit the Dose Configuration feature.

## Setting dose alerts (system limits)

1. Select **System**. The **System** screen appears.
2. Select **System Settings**. The **System Settings** screen appears.
3. Select **Dose Configuration**.
4. The **Dose Configuration** dialog box appears.

**Note:** The default **Dose Alerts (System Limits)** which are set at 1000mGy CTDI and 2000 mGy cm DLP are designed to prevent the patient from receiving any possible deterministic effects due to excess dose. However, the system allows these values to be modified by the user. Any modifications to the **Dose Alerts (Systems Limits)** should be made by qualified medical personnel.

5. To define the **Dose Alert (System Limits)**:
  - Enter the **CTDIvol (mGy)** value in the text box using the dropdown menu and select the Checkmark to save the value.
  - Enter the **DLP (mGy.cm)** value in the text box using the dropdown menu and select the Checkmark to save the value.



Figure 99: Define dose alert

6. Select **Set** to save the new values.
7. When finished select **Close** to exit the Dose Configuration feature.

If a Dose Alert is triggered by a series of planned scans who's combined CTDI or DLP exceeds the Alert value, a Dose Alert message will be displayed on the tablet.

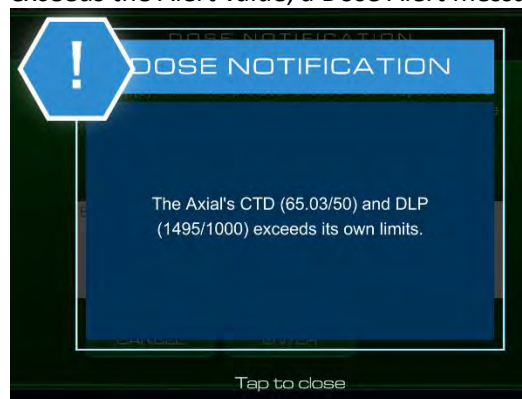

Figure 100: Dose alert

When you 'Tap to close' the above screen the following message box will appear, asking you to enter a password and a Diagnostic Reason for exceeding the set Dose Alert value.

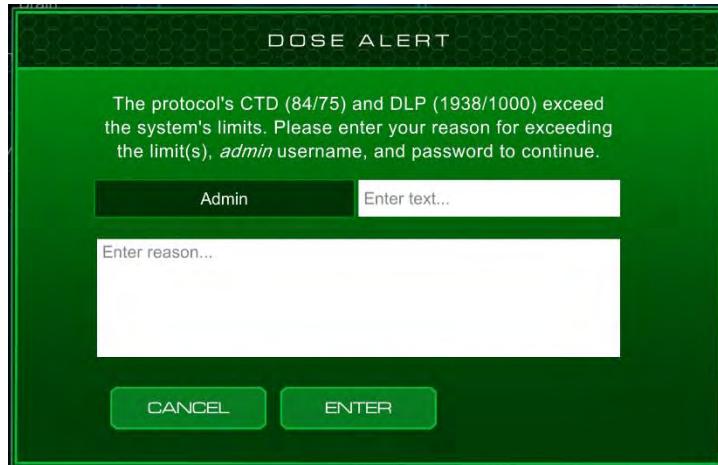

Figure 101: Dose alert dialog box

You can either enter a reason and select Enter or select Cancel and modify the protocol parameters to reduce the CTDI or DLP below the Dose Alert Limits.

---

## Managing DICOM servers

**Digital Imaging Communication in Medicine (DICOM)** is the definition of the acronym **DICOM**. **DICOM** servers are used to export images from the scanner. The **PACS Configuration** option lets the administrator access all possible storage servers created in the system by the **field service engineer**.

See **DICOM** standards on the **NEMA.org website** for a full description of settings (and actions) that are available.

**DICOM** servers are initially set up by the **Field Service Engineer** and the appropriate IT person at the hospital.

**Note:** You must have administrative access privileges and be logged in as an administrator to access this area in the application.

1. Select the **System** icon. The **System** screen appears.
2. Select **System Settings** icon. The **System Settings** screen appears.
3. Select the **PACS Configuration**. The **PACS Configuration** dialog box appears.

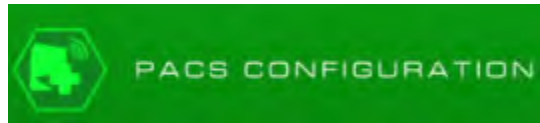

Figure 102: PACS Configuration icon



Figure 103: PACS configuration dialog box

4. Select the new default **PACS Server** from the dropdown.
5. Select **Close**.

**Note:** Any changes you make to the default server will be reset when the tablet is restarted.

## Setting up the audit trail viewer

The administrator sets up the Audit Trail Viewer to build an audit trail, which monitors and/or reports changes that are made – from all users who logged in. Changes may include modifying presets or any other activities. These users include operator, administrator, or service-related users that make changes to the system.

**Note:** You must have administrative access privileges and be logged in as an administrator to access this area in the application.

1. Select the **System** Icon. The System screen appears.
2. Select **System Settings** icon. The **System Settings** screen appears.
3. Select the **Audit Trail Viewer** icon. The **Audit Trail Viewer** dialog box appears.

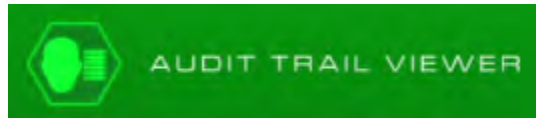

Figure 104: Audit Trail Viewer icon



Figure 105: Audit trail viewer dialog box

4. From the Audit Trail Viewer dialog box, select a date or date range with the calendar to show when changes were made.
  - To select a single date, press on the date on the calendar to find audits for that date. See the calendar in the next figure.



Figure 106: Calendar dialog box

- To select a span of time, select the **From** box and select a start date (on the calendar) and then select the **To** box and select the end date on the calendar. This approach lets you select a range of audits done in a specified span of time. See the text boxes to the right of the calendar; the top text box is where the start date will show when you select a start date on the calendar; the bottom text box is where the end date will show when you select an end date on the calendar.



Figure 107: Audit trail viewer options

5. Select the **Audit Type** dropdown to select the kind of audit you are searching for.
6. From the **User ID** dropdown, select the type of user to track.
7. Select the **View** button to see the result of audits that met your criteria. The results will appear.

## Setting recon presets

Recon Presets allow the administrator to define and customize reconstruction presets. Recon Presets are listed in the preset dropdown menu in the Reconstruction tab.

The administrator can delete existing recon presets, update an existing recon preset, or create and save new recon presets.

1. Select the **System** icon. The System Screen appears.
2. Select **System Settings** icon. The **System Settings** screen appears.
3. Select the **Recon Presets** icon. The **Recon Presets** dialog box appears.



Figure 108: Recon Presets icon



Figure 109: Recon presets dialog box

4. Create a new Preset by selecting **New Preset**.



Figure 110: New preset dialog box

5. Enter the **Preset Name, Slice Spacing & Thickness, Metal Artifact, Window Width, Window Level, Noise Reduction, and Scan Type.**
6. Select **Save** to update new preset.

---

## Setting recon preset groups

Recon Preset Groups allow the administrator to define and customize reconstruction groups. Recon Groups can be added to a protocol to automatically start reconstructions from within the Acquisition tab.

The administrator can delete existing recon groups, update an existing recon group, or create and save a new recon group.

1. Select the **System** icon. The System Screen appears.
2. Select **System Settings** icon. The **System Settings** screen appears.
3. Select the **Recon Groups** icon. The **Recon Preset Groups** dialog box appears.



Figure 111: Recon Groups icon



Figure 112: Recon preset groups dialog box

#### 4. Create a new group by selecting **New Group**.



Figure 113: New recon preset group dialog box

5. Enter the **Group Name**, **Scan Type**, and **Recon Preset**.
6. Select **Save** to update new preset.

## Setting MPR presets

MPR Presets allow the administrator to define and customize MPR Presets.

The administrator can delete existing recon groups, update an existing recon group, or create and save a new MPR Preset.

1. Select the **System** icon. The System Screen appears.
2. Select **System Settings** icon. The **System Setting** screen appears.

3. Select the **MPR Presets** icon. The **MPR Presets** dialog box appears.



Figure 114: MPR Presets icon



Figure 115: MPR presets dialog box

4. Create a new preset by selecting New Preset.



Figure 116: New MPR preset dialog box

5. Enter the **Name**, **Slab Thickness**, and **Slab Spacing**.
6. Select **Save** to update new preset.

## Setting windowing presets

Windowing presets allow you to quickly set the Window Level and Window Width for your images.

The administrator can delete existing windowing presets, update an existing windowing preset, or create and save a new windowing preset.

1. Select the **System** Icon. The System Screen appears.
2. Select **System Settings** icon. The **System Settings** screen appears.
3. Select the **Window Presets** icon. The **Windows Preset** dialog box appears.

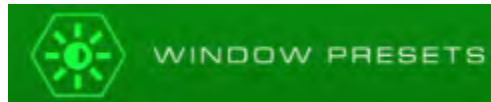

Figure 117: Window Presets icon



Figure 118: Window preset options

4. Create a **New Preset** by entering the name, window level, and window width and select **Add**.
5. To edit a **Preset**, select the **Preset icon**.



Figure 119: Window preset option

6. Make desired changes and select **Set** to update **Preset**.

## Selecting image orientation

NeuroLogica describes patient orientation as if the viewer were looking towards the front of the gantry (where the Mood Ring is). In other words, if the patient is lying face up with their head in the gantry, the image orientation displays the patient's Right side on the Left side of the Viewer. If the patient's feet are going into the gantry, the image orientation displays the patient's Left side on the Left side of the Viewer.

The MPR Image Orientation will always display in the preferred anatomical viewing orientation, where the patient's Right side is on the Left side of the viewer.

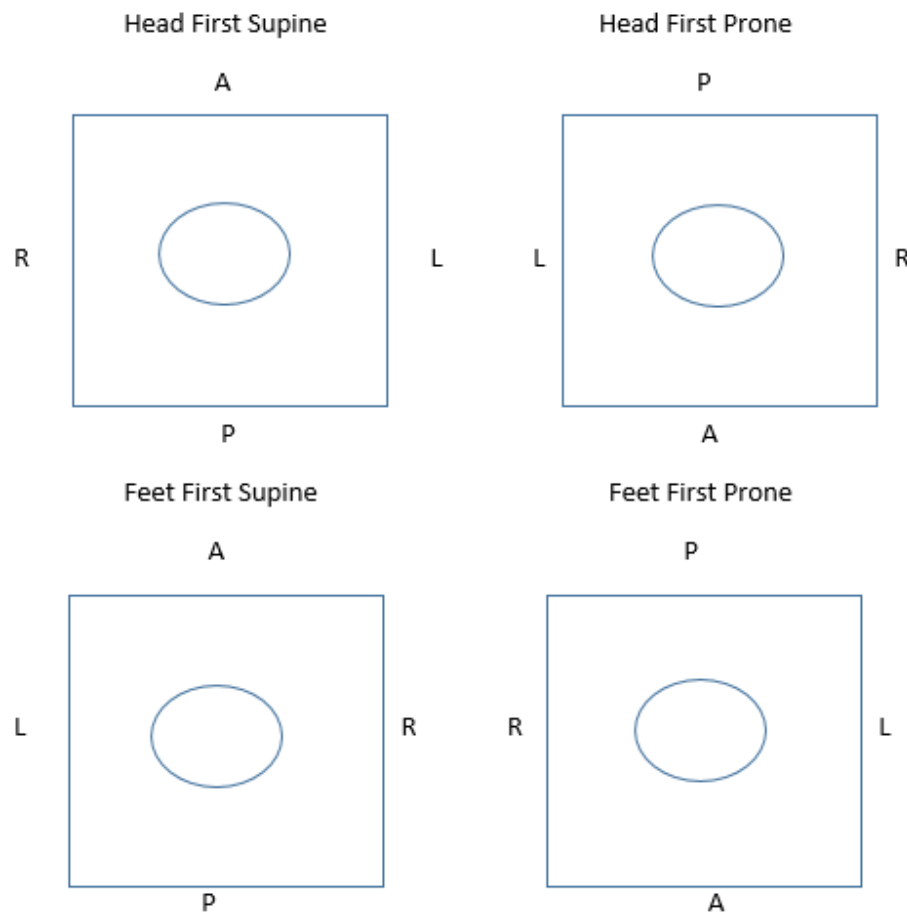

Figure 120: Image orientation

**Note:** Image Orientation is not a customizable configuration for OmniTom Elite.

A user can modify patient orientation, but the view will always be as if the viewer were at the patient's feet for the anatomical position.

**Patient Orientation** abbreviation list:

<b>HFS</b>	Head First-Supine
<b>HFP</b>	Head First-Prone
<b>HFDL</b>	Head First-Decubitus Left
<b>HFDR</b>	Head First-Decubitus Right
<b>FFS</b>	Feet First-Supine
<b>FFP</b>	Feet First-Prone
<b>FFDL</b>	Feet First-Decubitus Left
<b>FFDR</b>	Feet First-Decubitus Right

You can modify patient orientation by selecting either arrow as shown in Figure 121.



Figure 121: Patient orientation toggle

**Note:** Always verify that your patient is in the correct orientation, prior to scanning.

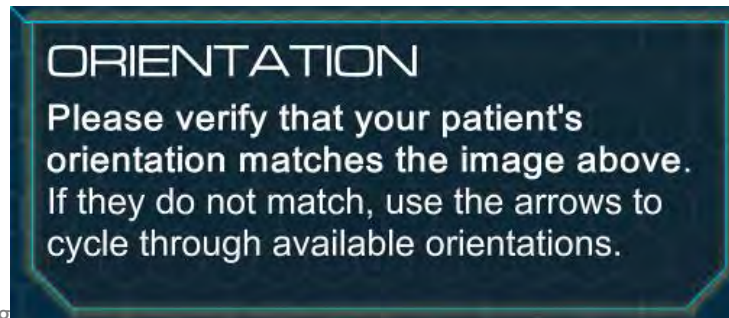

Figure 122: Orientation verification dialog

## Chapter 6 Protocol Manager

**Note:** You must have administrative access privileges and be logged in as an administrator to access this area in the application.

Incorrect changes to the system configuration may make the system inoperative.

**Protocol Manager** lets you set how the limited and restricted operator uses protocols. **Protocol Manager** also provides two patient options: Adult and Pediatric patient.

### Creating a new protocol

1. Select **System Icon**.
2. Select **Protocol Manager**. The Protocol Manager dialog appears.



Figure 123: Protocol manager for adult and pediatric patients

3. Select one of the following:

<b>Adult</b>	To scan adult patients. Set adult protocols are stored by anatomical area, here.
<b>Pediatric</b>	To scan pediatric patients. Set pediatric protocols are stored by anatomical area, here.

**Note:** Adult and pediatric protocol parameters are customized to meet your requirements in conjunction with local and nationally recognized published guidelines. These protocols **must be** approved by your facility physicist **before** the system's acceptance.



**WARNING**

Any modification to an existing protocol, or any new protocol created, should be reviewed, and approved by a radiologist and/or residing medical physicist. Failing to do so could cause a patient to receive an excessive and/or unnecessary dose of ionizing radiation.

Resources for radiation protection of pediatric patients appear below and are for referring physicians with a focus on radiation exposure:

- American Academy of Pediatrics (AAP) <https://www.aap.org>  
Search for radiation risk to children from Computed Tomography
- Federal Drug Administration (FDA), <https://www.fda.gov>  
Search for guidelines for pediatricians regarding medical radiation safety
- American College of Radiology (ACR):  
[https://acsearch.acr.org/listAppropriateness Criteria®\\_guidelines](https://acsearch.acr.org/listAppropriatenessCriteria®_guidelines)
- Image Gently® and CT scans
- Image Gently/FDA Digital Radiography Safety Checklist:  
<https://www.imagegently.org/Portals/6/Procedures/Attachment%20D.CR.DR%20%20checklist.pdf>

**Note:** The **New** button and others (depending on what was done previously) are active **after** you select a colored orb corresponding to the body part and then select the protocol that shows in the **Protocol** list. Existing protocols appear in the **Protocol** list box, as shown, in the figures below.

4. Select the **New** button to create a new protocol.



Figure 124: Protocol Manager New Protocol

5. The **New Protocol** dialog box appears.



Figure 125: New protocol dialog box

The **Protocol Information** and **Protocol's Series** areas are *empty*. The **Patient Position** settings are identical whether it is for an adult, pediatric, or emergency patient.

For **Protocol Information**, enter your information in the following text boxes:

<b>Protocol Name</b>	The name of the protocol as it will be displayed in the protocol manager. Factory Protocols begin with the letters NL.
<b>Protocol Description</b>	The description of the protocol you assign; for example, <b>Axial</b> head or <b>Helical</b> head.
<b>Anatomical Reference</b>	References what part of the anatomy will be scanned; for example, head or chest.
<b>Default Study Description</b>	The <b>DICOM</b> image tag; if entered, this description will also appear in <b>PACS</b> as a <b>Study Description DICOM</b> tag (00081010).

- After adding all required **Protocol Information**: Protocol Name, Protocol Description, Anatomical Reference, and Default Study Description, select **Add**.
- Under **Protocol Series**, select the **New** button. The **New Series** dialog box appears.

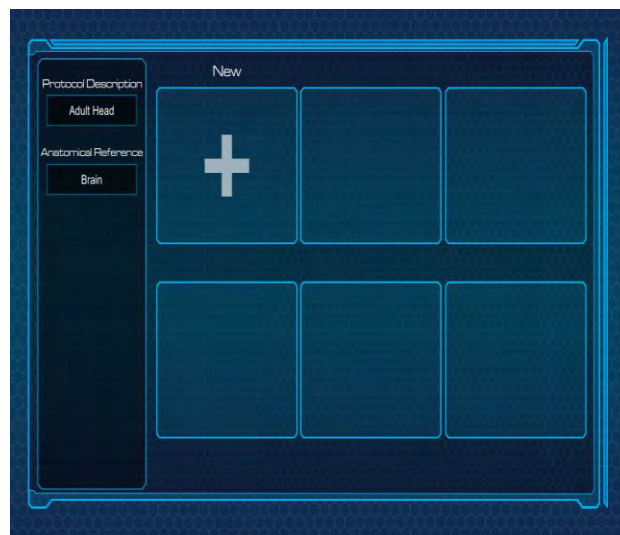

Figure 126: New series dialog box

- For **Type**, select one of the following:
  - Axial
  - Helical
  - Reference
  - Scout
- For **Scout Type**, select one of the following:
  - AP
  - PA
  - Lateral

**Scout Type** is not available for **Axial**, **Helical**, and **Reference** scan modes.
- For **Body Part**, select the appropriate Body Part from the dropdown menu.
- For **Description**, enter the defined study description.

12. For **kV** (scan voltage), select one of the following:
  - 70 To set the scan kV to 70
  - 80 To set the scan kV to 80
  - 100 To set the scan kV to 100
  - 120 To set the scan kV to 120
  
13. For **mA** (scan current), select the appropriate selection (2.5 to 45 mA with an increment of 2.5 between 2.5 and 15 and increments of 5 between 15 and 45mA) from the dropdown. Maximum scan current (mA) is reduced in higher power (kV) scan when in Axial mode. The maximum scan current can range from 2.5 to 45 mA based on available x-ray tube heat capacity and kVp selection. X-ray tube power of any scan combination is computed as the product of the scan voltage and the scan current.

The scan time is determined by the x-ray tube's current heat capacity.

$$\text{Scan Power} = \text{Scan Voltage (kV)} \times \text{Scan Current (mA)}$$
  
14. For **Scan Time**, if applicable, the calculated number appears here, depending on other selections.

The scan time is automatically calculated based on the parameters selected. For example, the **Scan Time** for an axial 120mm scan with 2 seconds per scan is 24 seconds. The **Scan Time** for a helical scan with same coverage is 12 seconds (1 second scan).
  
15. For Coverage (**mm**), enter the total scan distance.
  
16. For **Number of images**, if applicable, the calculated number appears here.

The number of images is calculated based on the slice thickness and length of the scan.
  
17. For **Window Width**, enter the range of CT numbers that are distributed over the viewable gray scale of the display device or film.
  
18. For **Window Level**, enter the CT number in the center of the viewable gray scale.
  
19. For **Kernel**, select the image reconstruction kernel from the following list of kernels:
  - **Soft Tissue**
  - **Posterior Fossa**
  - **Sharp**
  - **Bone**

**Kernel** allows *only* **Soft Tissue** for **Reference** scan mode and *only* **Posterior Fossa** for **Scout** scan mode.
  
20. For **Slice Thickness/Spacing**, select from the following options:
  - In **Axial** scan mode, **slice thickness** is the same as slice spacing.
  - In Helical scan mode, the slice spacing can be different from slice thickness, based on pitch.
  - **Slice Thickness/Spacing** is not available for Scout scan modes.
  
21. For **Rotations**, select one of the following scan times:
  - 1 Second(s)
  - 2 Second(s)

**Rotations** is available for **Axial** and **Reference** scan mode, *only*.

22. For **Pitch**, there is only one selection for travel time (per scanner rotation):1; the scanner is moving at 10mm per second.

**Pitch** describes a scanner's travel and how fast the scanner is moving per rotation; **Pitch** is available for **Helical** scan mode, *only*.

23. For **Scan Delay**, select options and enter the delay time that will occur after pressing the **Start Scan** button and before the scan begins.

24. For **CTDIvol (mGy)**, if applicable, the calculated number appears here, depending on other selections.

**CTDIvol (mGy)**, applies an unknown to **Scout** scan modes; it applies 12.6 for **Helical** and 50.4 for **Reference**.

**CT Dose Index Volume (CTDIvol)** represents the dose for a specific scan protocol, which considers gaps and overlaps between the radiation-dose profiles from consecutive rotations of the x-ray source. The CT Dose Index Volume is noted as CTDIvol. The CTDIvol is calculated differently for both the **Axial** and the **Helical** modes:

- For **Axial** scan mode:  $CTDIvol = [ (N \times T)/I ] \times CTDIw$
- For **Helical** scan mode:  $CTDIvol = 1/pitch \times CTDIw$

**Dose Length Product (DLP)** is the measure of ionizing radiation exposure during the entire acquisition of images. Therefore,  $DLP (mGy.cm) = CTDIvol (mGy) \times irradiated \text{ length (cm)}$ .

25. Select the **Enable AEC** option, if applicable.

<b>Enable AEC</b>	Allows you to automatically adapt the tube current or mA according to the patient's body habitus in order to achieve the specified image quality at the lowest possible dose.
-------------------	---

For detailed information on this feature, refer to *Scanning with special features* on page 179.

26. Select the **Noise Reduction** option, if applicable for Axial scan mode only.

<b>Noise Reduction</b>	Allows you to select Low, Medium or High levels of Noise Reduction to decrease noise in Axially scanned images only.
------------------------	--

For detailed information on this feature, refer to *Scanning with special features* on page 179.

---

## Adding a New Protocol using Copy from an Existing Protocol

1. Select **System Icon**.
2. Select **Protocol Manager**. The Protocol Manager dialog appears.



Figure 127: Protocol manager

3. Select one of the following:

<b>Adult</b>	To scan adult patients. Set adult protocols are stored by anatomical area, here.
<b>Pediatric</b>	To scan pediatric patients. Set pediatric protocols are stored by anatomical area, here.

**Note:** Protocol parameters are customized to meet your requirements in conjunction with local and nationally recognized published guidelines. These protocols **must be** approved by your facility physicist **before** the system’s acceptance.



**WARNING**

Any modification to an existing protocol, or any new protocol created, should be reviewed, and approved by a radiologist and/or residing medical physicist. Failing to do so could cause a patient to receive an excessive and/or unnecessary dose of ionizing radiation.

Resources for radiation protection of pediatric patients appear below and are for referring physicians with a focus on radiation exposure:

- American Academy of Pediatrics (AAP) <https://www.aap.org>  
Search for radiation risk to children from Computed Tomography
- Federal Drug Administration (FDA), <https://www.fda.gov>  
Search for guidelines for pediatricians regarding medical radiation safety
- American College of Radiology (ACR):  
[https://acsearch.acr.org/listAppropriateness Criteria® guidelines](https://acsearch.acr.org/listAppropriatenessCriteria%20guidelines)
- Image Gently® and CT scans
- Image Gently/FDA Digital Radiography Safety Checklist:  
<https://www.imagegently.org/Portals/6/Procedures/Attachment%20D.C.R.DR%20%20checklist.pdf>

**Note:** The **New** button and others (depending on what was done previously) are active **after** you select a colored orb corresponding to the body part and then select the protocol that shows in the **Protocol** list. Existing protocols appear in the **Protocol** list box, as shown, in the figures below.

- Select the protocol you want to Copy to create a new protocol and tap the Copy button.



Figure 128: Copy Protocol



Figure 129: Copied Protocol

- The **Protocol Information** and **Resolution**, which is used for protocol filtering, is copied from the previous protocol, modify that information as required and select **Save**.

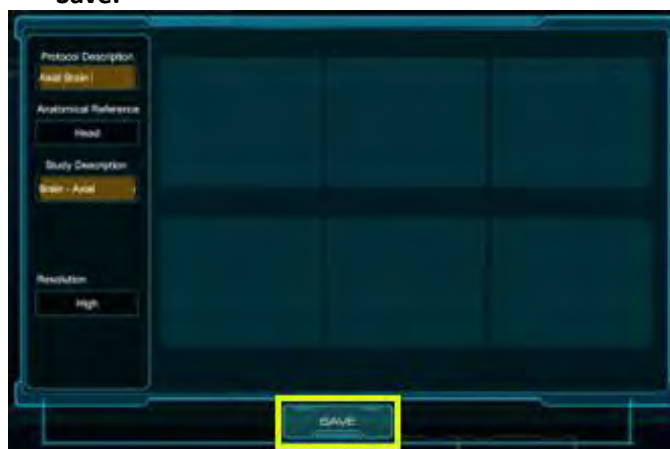

Figure 130: Save Modified Protocol

- The copied protocol series will appear.



Figure 131: Copied Protocol

6. Modify and add an additional series required and select **Save**.

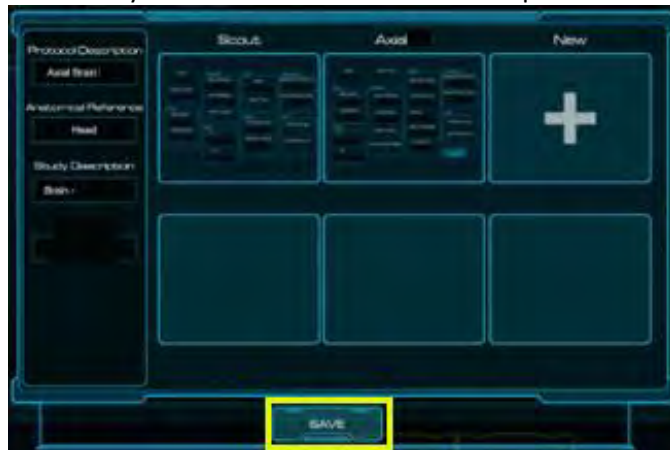

Figure 132: Save Copied Protocol

## Editing an existing protocol

The **Edit** button is used in **Protocol Manager** to edit an existing protocol. Protocols that begin with “NL” are NeuroLogica reference protocols and cannot be edited or deleted.

1. Select **System Icon**.
2. Select **Protocol Manager**. The **Protocol Manager** dialog appears.
3. Select one of the following:







<b>Adult</b>	Adult protocols are stored by anatomical area, here.
<b>Pediatric</b>	Pediatric protocols are stored by anatomical area, here.

By selecting either an **Adult** or **Pediatric** patient, the corresponding list of saved protocols becomes available.

**Note:** Adult and pediatric protocol parameters are customized to meet your requirements in conjunction with local and nationally recognized published guidelines. These protocols **must be** approved by your facility physicist **before** the system’s acceptance.

- Select the icon corresponding to the appropriate body part.

Table 25: Anatomical orbs

Icon	Icon Name
	<b>Brain</b>
	<b>Spine</b>
	<b>Lung</b>
	<b>Upper Extremity</b>
	<b>Abdomen</b>
	<b>Lower Extremity</b>

- Select the protocol you wish to edit in the **Protocol** list.
- Select the **Edit** button.



Figure 133: Edit button illuminated

- The **Edit Protocol** dialog box appears.

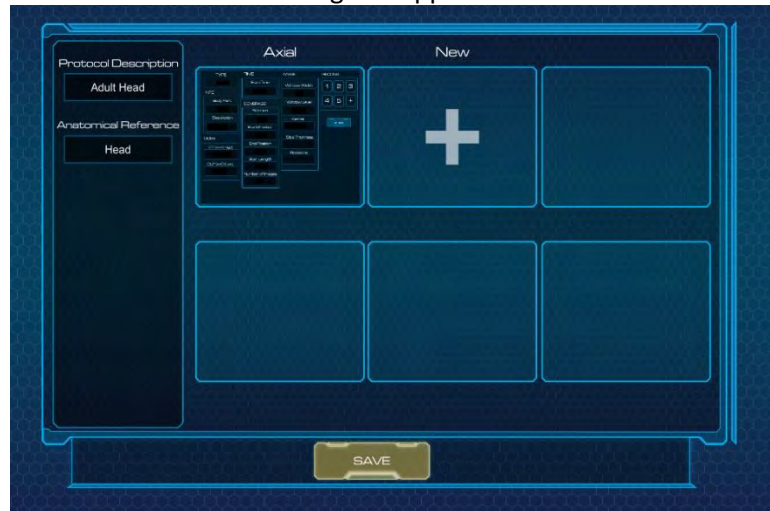

Figure 134: Edit protocol dialog box

- Make your changes.  
See “Creating a new protocol” on page 126 to learn how the fields and options perform to make informed choices on what to change.
- Select the **Update** button to save your changes to the existing protocol.
- Select the **Save** button to finish saving to the **Protocol Manager**.
  - Select the **Cancel** button to return to the previous dialog box.
- Select the **Close** button to exit.

## Deleting a protocol

- Select **System Icon**.
- Select **Protocol Manager**. The Protocol Manager dialog box appears.
- Select one of the following:

<b>Adult</b>	Adult protocols are stored by anatomical area, here.
<b>Pediatric</b>	Pediatric protocols are stored by anatomical area, here.

By selecting either an **Adult** or **Pediatric** patient, the corresponding list of saved protocols becomes available.

**Note:** Protocols that begin with “NL” are NeuroLogica reference protocols and cannot be edited or deleted.

- Select the icon corresponding to the appropriate body part.
- Select the protocol from list to be deleted.



Figure 135: Protocol manager with a protocol selected for deleting

6. Select the **Delete** button.



Figure 136: Delete protocol icon

7. The Delete Confirmation pop-up appears.

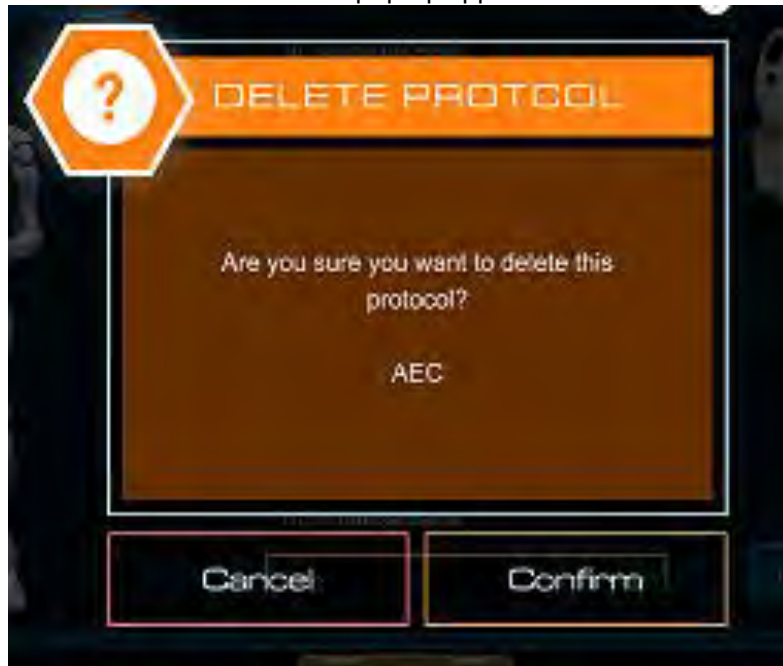

Figure 137: Delete protocol confirmation pop-up

Perform one of the following in the **Delete Protocol Confirmation** pop-up:

- Select the **Confirm** button to delete the selected protocol.
- Select the **Cancel** button to return to the Protocol Manager dialog box.

8. The **Delete Protocol Confirmation** dialog box disappears, and the **Protocol Manager** dialog box appears.

9. Select the **Close** button to exit.

---

## Hiding protocols

1. Select System Icon.
2. Select **Protocol Manager**. The Protocol Manager dialog box appears.
3. Select the icon corresponding to the appropriate body part.
4. Select the **Eye** icon next to the protocol you want to hide. A line through the **Eye** icon indicates that the protocol is hidden, as seen in Figure 138.



Figure 138: Protocol manager hide protocol function

---

## Moving protocols

1. Select **System Icon**.
2. Select **Protocol Manager**. The Protocol Manager dialog box appears.
3. Select the icon corresponding to the appropriate body part.
4. Select the Arrow icon next to the protocol you want to move. Grab the arrow and arrange the protocols in the order you want them listed.



Figure 139: Protocol manager move protocol function

## Chapter 7 Daily Calibration and Quality Assurance

This chapter will cover the daily steps needed to get the scanner ready for imaging. Part of that is to learn how to perform a daily air calibration and how to run the **Quality Assurance** (QA) tool that verifies the system is at its optimum performance. In addition, we will discuss some of the radiation safety issues such as the CTDI and the scatter from the scanner. The chapter will teach you how to predict the CTDI or patient exposure.

---

### Daily calibration

Keep in mind that **before** using the OmniTom Elite, you **must** perform a **Daily Calibration** to ensure that the system is at its optimum performance.

**Note:** If a Daily Calibration has not been performed for three days, a Tube Seasoning prompt will appear when the user logs in.

### Performing a daily calibration

**Note:** NeuroLogica recommends that an air calibration is performed once every six (6) hours, if the air freshness falls below 50%, or if the scanner is moved to an area with a dramatic change in humidity or temperature. Perform another air calibration to ensure optimum image quality during patient scanning.

If room-temperature fluctuations have occurred, you may need to perform more than one air calibration. In addition, scanners can drift out of alignment; make sure you perform a Quality Test with the test phantom before scanning a patient.

1. Be sure that nothing is in the bore before the daily (air) calibration takes place.
2. Make sure the shielding curtains (if fitted) are fully closed before beginning.
3. On the tablet, select **System Icon**. Select **Daily Calibration** icon.



Figure 140: Daily calibration dialog box

4. Press Begin to begin **Daily Calibration**

The **Daily Cal** has a built-in delay of ~10 seconds. The calibration takes ~ 1.5 minutes.

The progress of the daily calibration appears on the tablet.

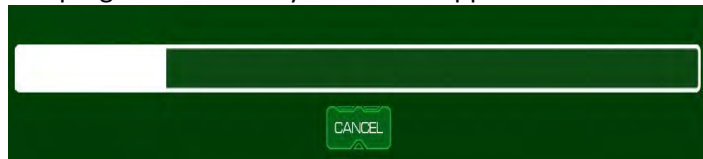

Figure 141: Daily calibration progress pop-up

5. To stop the scan, press the **Cancel** button.

6. The **Daily Cal icon** will change to green when it reaches 100% air freshness.



Figure 142: Daily calibration status

## Tube seasoning

If the system detects that a Daily Calibration has not been performed in at least three days, a **Tube Seasoning** prompt will appear when the user powers up the system and logs in. Press the **Continue** button to perform the Tube Seasoning. The Tube Seasoning will take approximately 15 minutes.

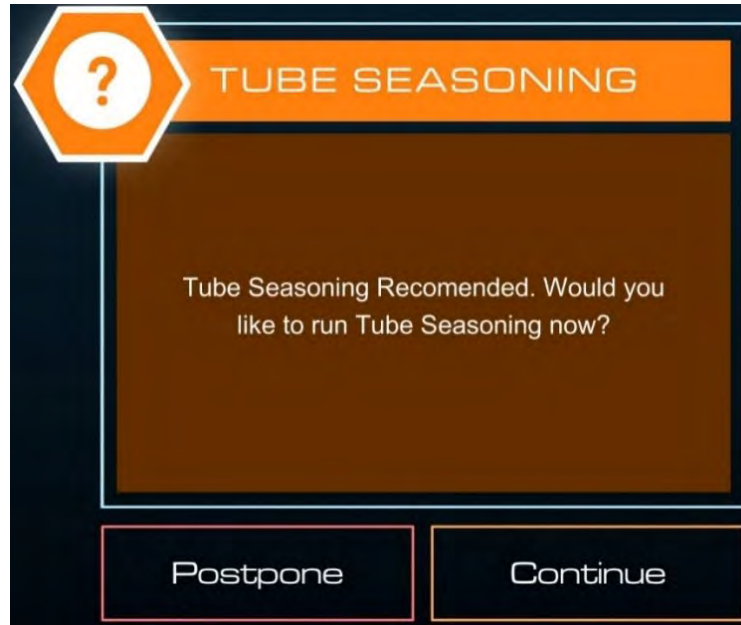

Figure 143: Tube seasoning prompt

The **Tube Seasoning** Dialog Box will appear. Press **Begin** after checking that there is nothing in the bore.

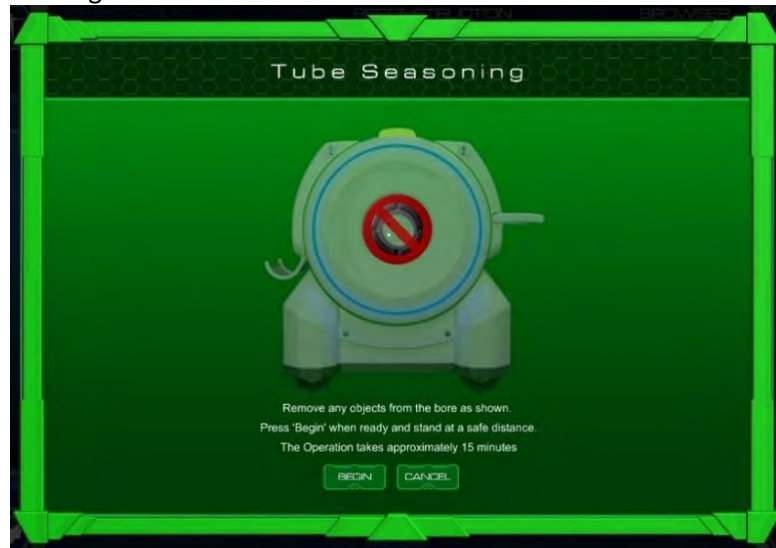

Figure 144: Tube seasoning dialog box

## The QA phantom overview

The **QA phantom** is a device that measures parameters that completely characterize image quality; these parameters are as follows:

- Uniformity
- Noise
- High-contrast resolution
- Slice width

- Low-contrast resolution
- Sensitometry (contrast scale)

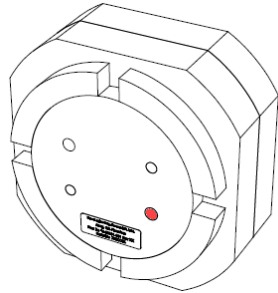

Figure 145: QA phantom

The **QA phantom** is a 20cm diameter disk consisting of a substrate made of **clear urethane** and containing specific inserts. The uniform area of the disk is used to measure uniformity and noise. Four other parameters are measured by the inserts in the substrate.

The disk is encapsulated in a foam casing that enables it to be correctly positioned in the scanner. In this user manual, when the phantom is referenced, the foam casing is also implicitly referenced.

A thin Tungsten wire that is positioned approximately 20mm from the center of the phantom is used for measuring both the axial and the tangential resolution of the scanner. The scanner impulse response is also called the **Modulation Transfer Function (MTF)**. The **MTF** curves are calculated using the wire image. Resolution is defined as the ability to distinguish small objects. It is expressed in line pairs per centimeter

Two inclined 1.5mm steel wires are used to measure the **slice width**. They are intended to determine scanner resolution along the Z axis, that is, in the direction that is perpendicular to the **Axial** plane. Resolution along the Z axis is expressed in terms of slice width in millimeters. Although one wire is sufficient to measure the Z axis resolution if its position is accurately known, a second wire is included to confirm the alignment. If the alignment was incorrect, the results of the slice width test would not be accurate.

The **low-contrast insert** is a compound insert. It is made of two half cylinders of different materials with a known contrast difference between them. The low-contrast insert is intended to measure the contrast resolution of the scanner. The contrast resolution is the ability to measure small differences in x-ray attenuation.

The **sensitometry inserts** are an air bore and cylinder made of different materials. They are intended to measure the contrast scaling of the scanner.

The QA scan protocols appear in the following table.

Table 26: Scan protocols used by the QA

Scan voltage	120 kV
Scan current	45 mA <sup>1</sup>
Scan time	1 seconds
Kernel	Posterior Fossa
Slice thickness	10mm

---

## Performing a quality assurance test

To ensure the system is at its optimum, factory-specifications level, the tablet provides Quality Assurance tools to verify the system's state and to perform image-quality verification.

Before you begin this section, be sure to run a fresh **Daily Calibration** on the system using the tablet.

The QA protocol is shipped with the system and appears when you click **Quality Assurance** from the System Panel (on the bottom, right corner of the screen on the tablet). You cannot customize or modify the QA protocol.

Before beginning the **Quality Assurance** test, make sure a QA phantom is available and ready to position in the bore.

**Note:** The Quality Assurance test should be conducted per the local (hospital) requirements; scanning the QA phantom is done daily, weekly, or monthly, typically it should be done on a daily basis or prior to any scheduled use of the scanner.

1. Place the **QA phantom** in the bore.
2. On the LCD touch screen, press the **Laser On** button.

**Note:** The phantom label should face the front of the scanner and be positioned at the bottom. The red insert should be on the operator's bottom right when facing the scanner. The position of the phantom will greatly affect the QA results.

<sup>1</sup> - Axial scans at 120kV with 1 rotation will be limited to 25 mA, at 2 rotations 30mA

- Align the phantom by lining the QA phantom's etching (line(s)) with the laser light.

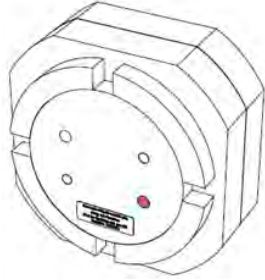

Figure 146: Phantom's etchings appear on top and sides

**Note:** The laser will automatically shut off 10 seconds after pressing the Laser On button.

- On the tablet, select **System Icon**, then select **Quality Assurance**. The **Quality Assurance Dialog Box** will appear.

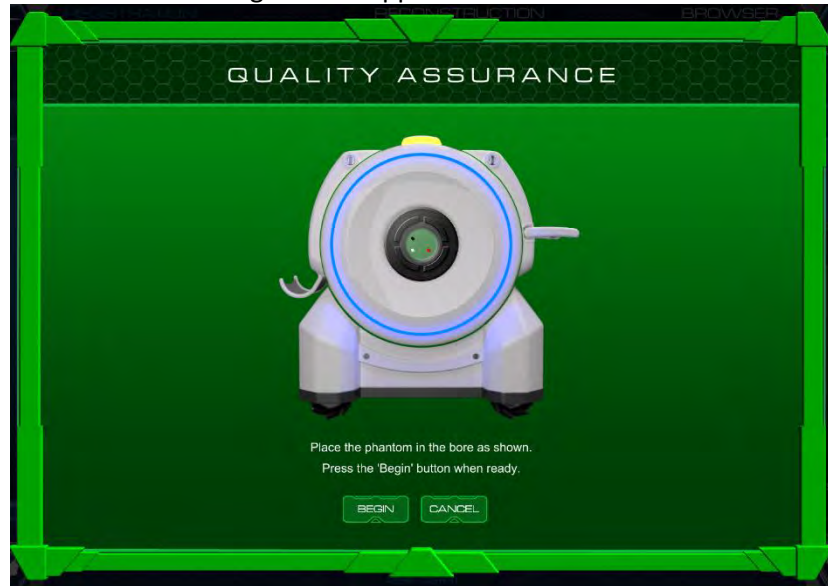

Figure 147: Quality assurance dialog box

- Press the **Begin** button. The scan delay (10 seconds) will appear on the LCD.
- Press the **Start** button on the LCD.
- Wait for the Quality Assurance results to appear.
- Review the results.
- Click the **Close** button on the QA Results pop-up when finished reviewing.



Figure 148: Quality assurance results

**Note:** Items in orange are failed results; reposition your phantom to perform another scan. Often positional issues cause the failure. If you try multiple times and failures persist, call your service representative. Review the results.

The QA image and QA results screen are available for viewing from the Browser and will show as two separate files on the Browser screen.

## Ensuring good image quality

In order to produce consistent image quality over the system's lifetime, it is strongly advised that you:

- **Establish and maintain** a regular **Quality Assurance (QA)** program. NeuroLogica typically recommends a weekly QA test. For infrequent use NeuroLogica recommends running the QA prior to scanning.
- **Keep** a record of the QA results. QA images are typically stored.
- **Review** the record periodically to check the consistency of the test results. Contact Customer Services if the QA performance is degrading over time.

**Note:** If you notice degradation in image quality or a change in QA values; schedule a site visit and let a Field Service Representative or Imaging Physicist run more detailed tests.

## OmniTom Elite dose information (21 CFR 1020.33 c)

For a technique of 45mA, 1 second and 120 kV the expected CTDI<sub>100</sub> center dose is 35.3mGy. The CTDI<sub>100</sub> surface dose is 40.83mGy. The weighted CTDI<sub>100</sub> dose is 45.0mGy. The Exposure was measured using the Service interface. For other scanning voltages, these CTDI<sub>100</sub> values are multiplied by the factors given in Table 28. The data in Table 28

represents the ratio of the CTDI at different scan voltages to the 120 kV scan voltage. For instance, the second entry of the second row shows that the Surface CTDI at 100 kV is 71% that of the 120kV using the same scan current. Then using the data from Table 27 one can calculate the surface dose at 100 kV.

Table 27: OmniTom Elite CTDI100 values

CTDI <sub>100</sub> Center (C)	CTDI <sub>100</sub> Surface (S)	CTDI <sub>w</sub> (W)
35.3	45.00	41.8

Table 28: Scan voltage weighting factors for dose calculations

kV	CTDI <sub>100</sub> Center (C)	CTDI <sub>100</sub> Surface (S)	CTDI <sub>w</sub> (W)
120	1.0	1.0	1.0
100	0.68	0.71	0.67
80	0.38	0.43	0.41
70	0.26	0.31	0.29

The weighted CTDI (**CTDI<sub>w</sub>**) is calculated as follows using the surface CTDI (**CTDI<sub>s</sub>**) and the center CTDI (**CTDI<sub>c</sub>**):

$$CTDI_w = \left( \frac{2}{3} \times CTDI_s + \frac{1}{3} \times CTDI_c \right) \text{ mGy}$$

Using the kV weighting factor, the CTDI<sub>w</sub> can be calculated using the following equation:

$$CTDI_w(kV, mA, S) = \left( W(kV) \times \frac{mA}{45} \times S \right) CTDI_w(120) \text{ mGy}$$

Where **W(kV)** is the **kV** relative dose ratio **mA** is the x-ray tube current in mA, and **S** is the scan time in seconds. For **axial** scan mode the CTDI volume depends on the scan increment **SI**, i.e., the transition between scans:

$$CTDI_{vol} = \frac{CTDI_w}{SI}$$

For **Helical** scans we report, consider the following:

$$CTDI_{vol} = \frac{CTDI_w}{Pitch}$$

For the OmniTom Elite *SI* and the *pitch* are both equal to one, as such, the CTDI volume is equal to the weighted CTDI. The dose-length product (DLP) is defined as the product of the CTDI<sub>vol</sub> multiplied by the scan length.

$$DLP = CTDI_{vol} \times \frac{\text{Scan Coverage in mm}}{10.0} \text{ mGy.cm}$$

The CTDI<sub>vol</sub> is measured in mGy and the DLP is measured in mGy.cm. 10.0 is the width of the detector array in Z.

## Sample calculation

For example, for an axial scan of 100 kV, 30 mA, 1 second with scan coverage of 170mm. The CTDI<sub>w</sub> is:

$$CTDI_w(100\text{ kV}, 30\text{ mA}, 1\text{ s}) = \left(0.67 \times \frac{30}{45} \times 1\right) 38.07 = 17.01\text{ mGy}$$

The DLP is:

$$DLP = 17.01 \times \frac{170}{10.0} = 289.17\text{ mGy}\cdot\text{cm}$$

For Helical scan mode the same calculation will be applied.

## The scout dose

The scout dose is calculated similarly to that of the helical scan mode. However, during scouts, the scanner moves at 30mm/sec which is equivalent to a pitch of 3, as such the CTDI:

$$CTDI_{vol} = \frac{CTDI_w}{3}$$

An 80 kV, 5 mA the scout will have the following CTDI<sub>vol</sub>:

1. The Weighted CTDI t 80 kV, 5mA can be calculated using the above equation:

$$CTDI_w(80\text{ kV}, 5\text{ mA}, 1\text{ s}) = \left(0.41 \times \frac{5}{45} \times 1\right) 38.07 = 1.734\text{ mGy}$$

2. The scout CTDI<sub>vol</sub>:

$$CTDI_{vol} = \frac{CTDI_w}{3} = \frac{1.734}{3} = 0.58\text{ mGy}$$

## Dose in clinical mode

In clinical mode the scan dose is slightly higher, approximately 10% higher due to the x-ray tube ramp up time. The dose will be measured in clinical mode, using the tablet. A special protocol is created for each kV. The scan protocol should have no scout since that will affect the location of the initial scan. The protocol for each scan voltage is set as follows:

Scan mode:	Axial
Scan voltage:	120 kV
Scan current:	30 mA
Scan time:	1 sec
Reconstruction kernel:	Posterior Fossa
Start position:	0mm
End position:	10mm

The same protocol will be generated for 100, 80, and 70 kV. The scan current and time can be adjusted according to physicist recommendation. The CTDI phantom should be positioned as close as possible to the scanner iso-center, preferably 5 to 10mm away from the scanner center. The CTDI is measured using the 2026c RadCal dosimeter and the 3cc ion chamber. The exposure was measured at the center of the phantom as well as the four peripheral positions at 12, 3, 6 and 9 O'clock positions. Appendix A shows the measurements for the 100 kV scan voltage. Table 29 lists the Center, Surface, and

Weighted CTDI measured using 30 mAs for all scan voltages. The measured CTDI<sub>vol</sub> can vary by as much as 20% from the predicted protocol scan value.

Table 29: The clinical dose measurement

kV	Normalized CTDI (mGy/1mAs)			
	120	100	80	70
Center	0.785	0.506	0.287	0.193
Surface	1.002	0.683	0.418	0.297
Weighted	0.929	0.624	0.374	0.262

To calculate the CTDI for any given protocol the following equation can be used:

$$CTDI_x = NormCTDI_x(mGy/mAs) \times ScanCurrent(mA) \times ScanTime(s)$$

$x$  can refer to either Surface, Center or Weighted CTDI. The Weighted CTDI of 120 kV scan with 25 mA scan current and 2 seconds scan time is:

$$CTDI_w(120kV, 25mA, 2s) = 0.929 \left( \frac{mGy}{mAs} \right) \times 25(mA) \times 2(s) = 46.45 mGy$$

The 0.929 is the Normalized weighted CTDI for 120 kV scan. The value is listed in the second column last row of **Table 29**. The Surface dose for a 100kV, 35 mA, 1 second scan can be computed similarly:

$$CTDI_s = 0.683 \left( \frac{mGy}{mAs} \right) \times 35(mA) \times 1(s) = 23.90 mGy$$

The Normalized Surface CTDI for 100 kV scan is the second entry in the second row under the 100kV subheading. Using the same scan parameters in the previous example. i.e., 100kV, 30 mA, 1 second scan and 170mm coverage. The clinical dose is:

$$CTDI_w(120kV, 30mA, 1s) = 0.624 \left( \frac{mGy}{mAs} \right) \times 30(mA) \times 1(s) = 18.72 mGy$$

Compared to 17.01 mGy calculated using the service measurements.

## OmniTom Elite dose in air

The dose in air for typical head scan of 120 kV, 35 mA, 2 seconds is 74 mGy. For a maximum technique of 120kV, 45 mA, 2 seconds, dose in air values are given by the following table.

Table 30: kV vs. dose in air

kV	Dose in air (mGy)
120	95.5
100	69.3
80	44.1
70	33.3

**Note:** All measurements are averages from ten trials and all measurements were within  $\pm 10\%$  of the mean.

## QA measurements

The QA phantom is typically used to monitor the scanner on site; however, the following phantoms can be used for measuring the imaging performance of the scanner: The scanner QA phantom, The ACR accreditation phantom and the CatPhan phantom. Other anatomical phantoms can also be used to test and monitor the scanner IQ.

### Finding high-contrast resolution

The high-contrast-resolution curves are calculated using the Tungsten wire placed near the center of a uniform disk. The wire simulates an impulse function in the **Axial** plane when it is placed parallel to the scanner-gantry axis-of-rotation. The scanner provides the impulse response to the wire. The impulse response is the scanner high-contrast resolution also known as the **Modulation Transfer Function (MTF)**. The MTF curves in Figure 149 and Figure 150 represents the gain of the scanner at different resolutions. The MTF can also be measured in lp/cm at different gain levels. For instance, the QA wizard reports the resolution at gains 50% and 10%. Variations of 10% may occur in measurements due to phantom placement error and measurement inaccuracies.

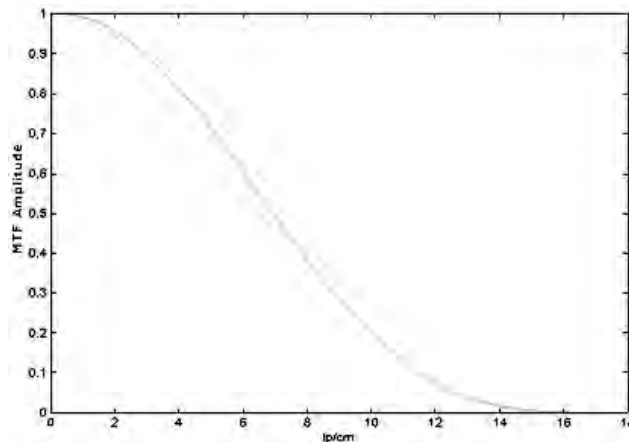

Figure 149: MTF at isocenter, shown for high resolution

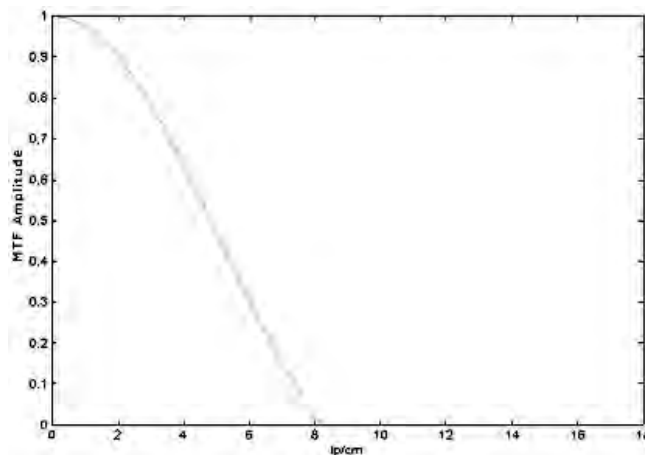

Figure 150: MTF at standard kernel

## Noise, uniformity, and mean CT number of water

One of two phantoms may be used in these tests. These are CatPhan® 412 or a cylindrical 20cm diameter water cylinder.

### OmniTom Elite noise measurements

**Noise** is measured as the standard deviation at isocenter. The value is  $5.2 \pm 2$  HU when the imaging protocol is 120 kV, 40 mAs and standard kernel. This protocol gives a  $CTDI_{100}$  center dose of 28 mGy.

### Uniformity and mean CT number

The mean CT number of air is -1000 HU and that of water is 0 HU. The tolerance of the mean CT number will be  $\pm 3$  HU. For mean CT numbers measured at different points of the water phantom, the maximum difference in the means will be less than 4 HU.

### Low-contrast resolution

The phantom used for low-contrast-resolution measurement is CatPhan 412.

### OmniTom Elite low contrast resolution

The **low-contrast resolution** is 3mm at 0.3% contrast when the center  $CTDI_{100}$  dose is 49 mGy. The imaging protocol is 120 kV, 70 mAs, 5mm slice thickness, and the standard reconstruction kernel.

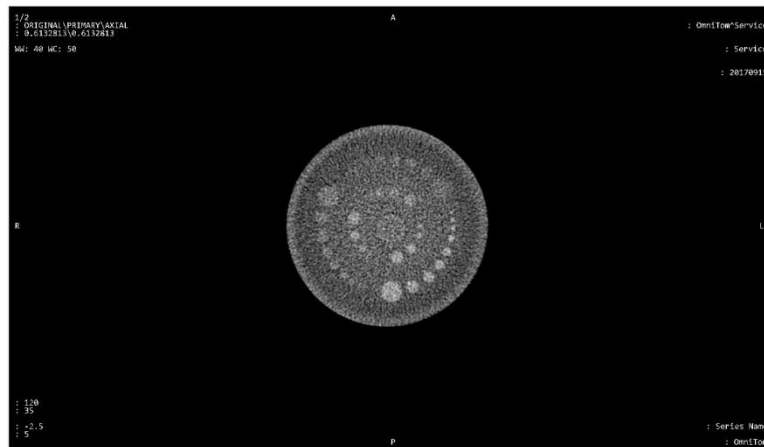

Figure 151: CatPhan 515 using 120kV, 45mA, 2 secs, and 5mm slice

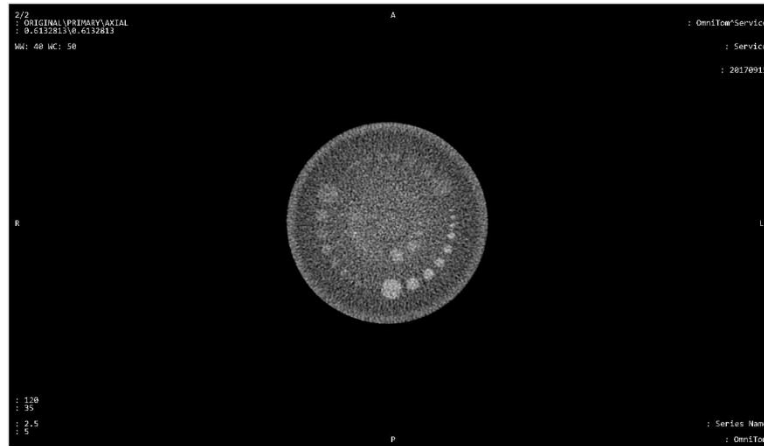

Figure 152: CatPhan 515 scanned using 120kV, 45mA, 2 secs and 5mm slice

## ACR validation

Each scanner undergoes an ACR validation procedure that includes the following tests:

- CT laser alignment
- CT linearity
- Slice width
- CT uniformity and noise
- Low contrast resolution
- High contrast resolution
- Beam width

The scanner needs to pass all the ACR requirements. The results will be saved for future reference. Due to its special beam quality the CT values do not meet the ACR requirements. According to ACR the CT values depend on the beam quality, and it is not considered a deficiency if the values do not meet the ACR requirements.

Table 31: The CT values for the ACR inserts at different kV levels.

Inserts	120 kV	100 kV	80 kV	70 kV
Air	-1005 to -970	-1005 to -970	-1005 to -970	-1005 to -970
Polyethylene	-110 to -85	-120 to -95	-140 to -125	-160 to -140
Water	-7 to 7	-7 to 7	-7 to 7	-7 to 7
Acrylic	110 to 135	105 to 125	90 to 115	70 to 90
Bone	1000 to 1100	1115 to 1215	1340 to 1440	1450 to 1650

## Beam width

The ACR accreditation requires measurement of the Beam Width. The beam width is defined as the width of the irradiated region along the z-axis. The beam can be measured using a radio chromic film or strip that is properly positioned at the iso-center of the scanner. Figure 153 shows the measured beam width of the scanner. Due to the

positional accuracy of the radio chromic film and the inaccuracy of the x-ray focal spot, the measured beam width of the scanner could vary between 11.7 and 14.3mm.



Figure 153: The measured beam width of the OmniTom Elite scanner

## Geometric efficiency in the Z axis direction

The geometric efficiency is the ratio of the integral of the dose profile integrated over the detector width in Z divided by the total CTDI<sub>100</sub>. The geometric efficiency is 70%. The geometric efficiency is equivalent to the beam width.

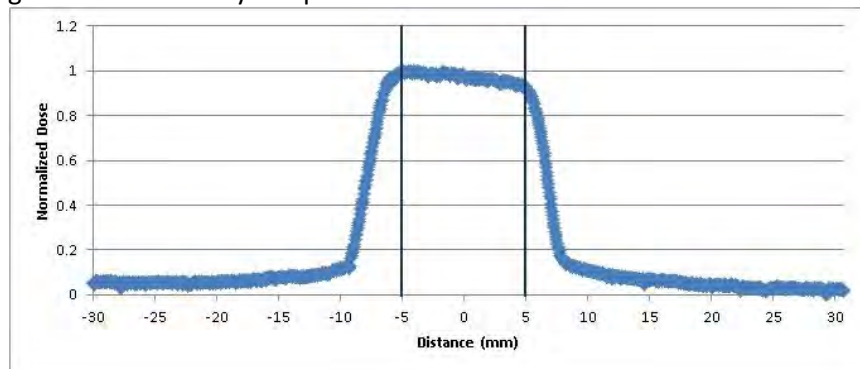

Figure 154: OmniTom Elite dose profile

**Note:** This profile is used to cover all available slice thicknesses since there is only one fixed collimation for the system.

## Slice sensitivity

The scanner is a 16-slice scanner, each slice is 0.625mm. The following two slice thickness definitions distinguish the acquired slice width and the reconstructed slice width:

**The acquired slice thickness:** This is the thickness of the detector element used in the acquisition. In the early days of multi-slice detectors, to reduce the amount of data transfer on the slip ring, detectors in the z-direction were added to minimize the data transfer rate, i.e., to build a 5mm slice using an array of 0.625mm the detectors were connected to create one 5.0mm detector. However, with the advances in chip technology scanners have unlimited bandwidth when it comes to data transfer from the disk to the reconstruction computer. Currently almost all scanners acquire the thinnest possible slice thickness. **In our case the nominal slice thickness for the data acquisition is 0.625mm.**

**The reconstructed image slice thickness:** This is the image slice thickness as defined by the user based on the scan protocol. For our scanner the allowable image thicknesses are: 0.625, 1.25, 2.5, 5 and 10mm. The thicker slices can be obtained by adding thinner

slices until the required thickness is obtained. For instance, on our scanner when the user requests 5.0mm images, all initial images are built using 0.625mm slices and every eight slices are added to create the 5.0mm.

Figure 155 and Figure 156 show the beads in the ACR phantom and its profile in the z-direction. The bead profile represents the slice sensitivity profile in the Z-direction of the scan nominal slice.

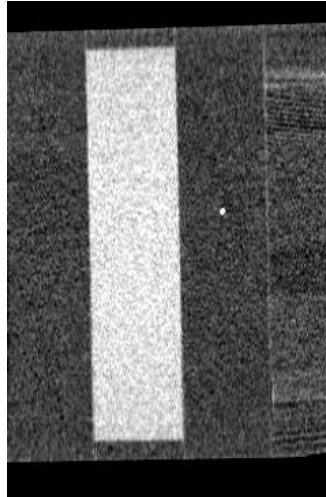
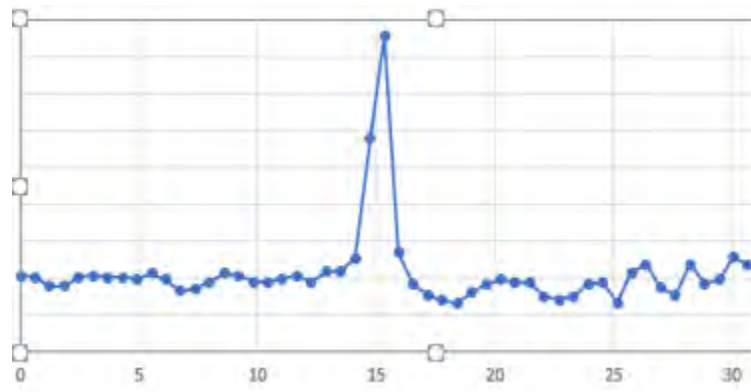

Figure 155: The sagittal reformat of the ACR scan using 0.625mm slices



Note:

-The units on the X-Axis are in millimeters (mm)

-The units on the Y-Axis are created at random by the imaging tool to show the magnitude of the profile, which is used to calculate the halfmax width

Figure 156: Slice sensitivity profile of 0.625mm axial scan of the ACR bead phantom

## Half-value layer

Table 32: Half-value layer

Scan voltage	70	80	100	120
Half value	3.8	4.5	5.7	6.8

## Allowable variations

The following are allowable variations:

<b>Dose</b>	A $\pm 5\%$ variation in dose may occur due to variations between systems and measurement differences. The maximum variation is $\pm 10\%$ . The ACR required that the measured dose be within 20% of the measured dose.
<b>High Contrast Resolution</b>	The variation in values on the MTF curve may be $\pm 10\%$ . These will occur mainly due to phantom placement errors, measurement inaccuracies and system variations.
<b>Noise</b>	The variation in standard deviation may be $\pm 10\%$ due to variations between systems.
<b>Uniformity</b>	The maximum difference between ROI means in an image is 4 HU. The maximum error in the CT number of water is $\pm 3$ HU.
<b>Beam Width</b>	The measured beam width should be between 11.7 and 14.3mm.

## Scatter radiation



**WARNING** Exposure to secondary radiation can be harmful, and OmniTom Elite usage should only be done under the direct supervision of the facility's qualified Radiation Safety Officer (RSO) in compliance with site, local, provincial, and national regulations. Only this RSO can perform the calculations necessary to determine what additional safety precautions are necessary, such as shielding, personal protections, etc.

**Note:** The OmniTom Elite scanners are compatible with IRR1999 and EU Directive 96/29/EURATOM.

The OmniTom Elite is the latest addition to the NeuroLogica family of mobile scanners. The OmniTom Elite is a head and pediatric scanner. The opening is 15cm bigger than its predecessor the CereTom to allow more diversified scan applications, for example, scanning the C-spine is now possible with the larger opening. Also, the scanner can accommodate an average size child up to seven years old. The front cover of the scanner is self-shielded with 0.3mm lead. The scanner is also equipped with lead curtains in the front and the back. The back curtain will limit the scatter from the top of the scanned subject. The front curtains can be closed around the scanned patient to limit the side scatter.

The scatter is measured using the 16cm CTDI phantom. The scatter was measured as follows:

1. The phantom is placed in the beam with the laser positioned at the middle point of the phantom.
2. The back curtain is fully closed.
3. The front curtains are partially closed. The opening is limited to 50cm, to emulate the presence of a patient.

4. The scatter was measured using the RadCal 2026c dosimeter with the 1800cc chamber for low level radiation measurements.
5. The chamber is positioned at a height of 1.0 m from the floor.
6. Measurements were taken at 1.0 and 2.0 m from the fan beam location.
7. The data was collected between -90° and 90° at 45° increments.
8. The scan protocol used for measuring the scatter was:
9. The scan voltage: 120 kV.
10. The scan current: 35 mA.
11. The scan time: 2 seconds.
12. Scan coverage is 10mm.

Figure 157 shows the setup of the scatter measurement. The data is used to create the isodose curves. The data is in  $\mu\text{R}$ . The data can be converted to mRem by multiplying by  $0.877\text{e-}04$  and to nSv by multiplying by 8.77. Table 33 shows the conversion rates between different radiation units.

Table 33: The energy conversion rates

	Multiply by
From $\mu\text{R}$ to mGy	0.00000877
From $\mu\text{R}$ to $\mu\text{Sv}$	0.00877
From $\mu\text{R}$ to mRem	0.000877
From mGy to $\mu\text{R}$	114025.0855
From mGy to mRem	100 mRem

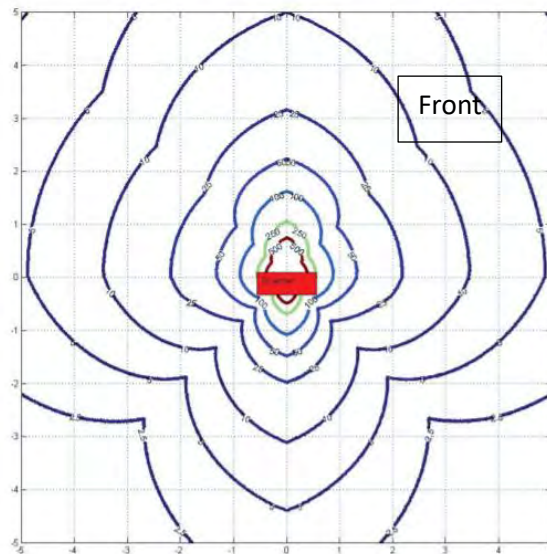

Figure 157: The scatter measurement setup

## Scatter exposure

Figure 158 shows the isodose curves generated from the above measurements. Figure 157 shows the measurement setup. The data is for a single 10mm coverage. In order to get the scatter for a longer scan, the data should be multiplied by the scan coverage. During a long scan, the scanner will be moving which might affect the measurement slightly.

Exposure isolines for 120 kVp, 35 mAs, Front curtain partially closed, Back curtain fully closed,  
No Patient Absorption



Measurement in  $\mu R$

Figure 158: The isodose curves for 120 kV, 70 mAs (using the CTDI 16cm phantom)

In Figure 158, the distances are in m, the scatter is measured in  $\mu R$ .

**Note:** The scatter measurements were done without considering the scatter absorption through the patient or the patient bed. This can be simulated using water bottles stacked in the back of the scanned phantom. A body phantom can also be used to simulate the patient absorption. This should reduce the scatter in the front of the scanner. We have seen a typical reduction of up to four between the uses of a water or CTDI phantom and the body phantom. The body phantom that can be used is manufactured by the Kyoto Kagaku company. *Figure 159* shows the body phantom.



Figure 159: The pediatric body phantom

**Note:** In compliance with IEC 60601-2-44, section 203.11, the previous figure shows the scatter radiation measured at the edge of the gantry in the tomographic plane is @20% of the scatter radiation measure at the same distance along the axis of rotation in the horizontal plane.

## CTDI measurements

In order to measure the CTDI Surface it is recommended that exposure measurements be taken at all four surface positions, averaged, and used to calculate the CTDI at the surface of the phantom. Measurements from two opposite surface locations will also be sufficient. i.e., the 12 and the 6 O'clock positions or the 3 and 9 O'clock positions. Using the 12 O'clock position only might overestimate the patient dose due to the configuration of the x-ray radiation. The Exposures are measured in mR. The CTDI is in mGy. Table 34 shows the measurement for the 100 kV scan voltage.

The exposure is measured three times at any given point. The three measurements were very consistent as seen in Table 34. The measurements are then averaged and used to calculate the CTDI using the following equation:

$$CTDI = \frac{E(R) \times 0.87 \left(\frac{rad}{R}\right) \times CL(mm)}{N \times T(mm)} \times 10 \left(\frac{mGy}{rad}\right) = E(mR) \times 0.087 \left(\frac{mGy}{mR}\right)$$

Table 34: The detailed dose measurement in a clinical scan mode

Position	m1	m2	m3	Average	CTDI	CTDI <sub>w</sub>
Center	174.4	174.3	174.8	174.5	15.1815	-
12 O'clock	270.2	269.7	270.5	270.1333	23.5016	20.72823
9 O'clock	211	212	211.5	211.5	18.4005	17.3275
6 O'clock	206.6	206.5	206.3	206.4667	17.9626	17.03557
3 O'clock	253.9	253.7	253.6	253.7333	22.0748	19.77703
Average Surface	-	-	-	235.4583	20.48488	18.71708

## Dose linearity with tube voltage and current

The dose or radiation output of the tube is linear with the tube current. The exposures are measured at two different scans at isocenter with and without a CTDI phantom. The following table shows the exposure in the CTDI head phantom.

Table 35: Exposure at two different mAs

120 kV, 20 secs, head CTDI	Exposure at iso (mR)
30	4550

10mA	1467
------	------

Table 36: Exposure at two different mAs

120 kV, 4 secs, in air	Exposure at iso
30mA	1389
10mA	455

Two linearity factors are computed. The first is the ratio of the exposure at different scan currents;  $F = \text{Exposure (I1)}/\text{Exposure (I2)}$ . The linearity factor is then compared to the current ratio. The F linearity factor should be within 10% of the scan current ration.

$$L_1 = \left| \frac{E(I_1)}{E(I_2)} - \frac{I_1}{I_2} \right| \leq 0.1 \frac{I_1}{I_2}$$

Table 37: Linearity calculations (mGy)

	CTDI head phantom	Air
$E_1/E_2$	3.102	3.053
$I_1/I_2$	3.0	3.0
$L_1$	0.102	0.053
Linearity Test (< 0.1)	0.034	0.017

The second linearity factor is computed as described in the IEC 60601-2-44 standard.

$$L_2 = \left| \frac{E(I_1)}{I_1} - \frac{E(I_2)}{I_2} \right| < 0.2 \frac{\left| \frac{E(I_1)}{I_1} + \frac{E(I_2)}{I_2} \right|}{2}$$

Table 38: Linearity calculations in accordance with IEC

	CTDI head phantom	Air
$E1/I1$	151.67	46.3
$E2/I2$	146.70	45.5
$(E1/I1+E2/I2)/2$	149.19	45.9
$L2$	4.97	0.8
Linearity test (< 0.2)	0.033	0.017

The radiation output is not linear with respect to the scan voltage; however, it is approximately linear with respect to scan voltage to the power of 2.3, that is  $E \propto kV^{2.3}$ .

**Note:** Actual results on installed units can vary +20% due to machine and test tolerances.

## Additional scatter measurements

Additional scatter measurements along the perpendicular plane were also taken using the CTDI head phantom with the back curtain closed and the front curtains partially closed to simulate a real scan; however, it should be noted that the scatter measured with the CTDI phantom *only* is typically higher than the actual scatter radiation from a

real patient. Due to the scanner height, the measurements were done at the positions noted in the next figure, which shows how to set up the system for scatter measurements.

The scatter measurements were done using the RadCal survey meter and the 1800cc probe.

The scatter was measured using the following scan protocol: 120 kV, 45 mA, 10 seconds. The following table lists the measured scatter per second in the back of the scanner.

Table 39: Scatter in vertical parallel to axis of rotation ( $\mu\text{Rem/s}$ )

	Distance from iso. (cm)		
	75cm	125cm	175cm
50cm below iso	16.8519	7.1688	4.06725
At iso	19.20525	8.61735	4.52835
50cm above iso	10.94025	6.6729	3.9759
75cm above iso	2.36205	4.6719	3.64095

Table 40: Scatter in vertical plane on patient side (mRem/s)

	Distance from iso. (cm)		
	75cm	125cm	175cm
At iso	0.428	0.155	0.075
50cm above iso	0.375	0.149	0.069
75cm above iso	0.274	0.140	0.070

**Note:** By design, this scanner's frame (about the bore) provides the primary shielding in the vertical plane perpendicular to the axis of rotation, therefore scatter radiation is negligible in this plane.

## Chapter 8 Registration

**Registration** is the first step in the patient scan process.

You can register a patient in the following ways:

- Manually register a patient for examination from the **Registration** tab.
- Perform a query to acquire already-entered patient data from the hospital (**Hospital Information System (HIS)**) or radiology system (**Radiology Information System (RIS)**).

It is assumed that the Tablet is connected to the site's **HIS/RIS** system. If you are not connected, you can always manually register the patient.



Figure 160: Active registration tab

### Navigating the Registration Screen – START HERE







Make sure the **Registration** tab is selected; press it if necessary.

Notice the buttons at the top and bottom of the **Registration** dialog box. Many of these buttons are active *only* if you are already connected to the site's **HIS/RIS** or if you selected the **Query** button (to query for patients and the list of patients populated in the **Query Results** list). When a patient is selected, the buttons are active.



Figure 161: Registration dialog box

Table 41: Registration buttons

Registration buttons	Action
	<p>Searches the <b>HIS/RIS</b> server for scheduled patients. The population of patients could take several minutes to appear, depending on the number of patient entries the query retrieves after pressing the <b>Query</b> button.</p>
	<p>Registers the selected patient and then takes you to the <b>Acquisition</b> tab select a protocol to be used for scanning.</p>
	<p>Shows selected patient details.</p>
	<p>Searches queried patient entries for specific information.</p>
	<p>Selects patient(s) from query results and moves them into <b>Stored List</b>.</p>
	<p>Removes patient(s) from the <b>Stored List</b>.</p>
	<p>Manually enters a new patient including the Patient ID information, and when completed, takes you to the <b>Acquisition</b> tab to select a protocol to be used for scanning.</p>

## Registering the patient

The following procedures show you how to enter patient information into the system before scanning the patient.

## Querying patient information

1. If necessary, select the **Registration** tab on the main screen.



Figure 162: Registration tab

2. Select the **Query** button at the top of the screen. The **Query Information** dialog box appears.

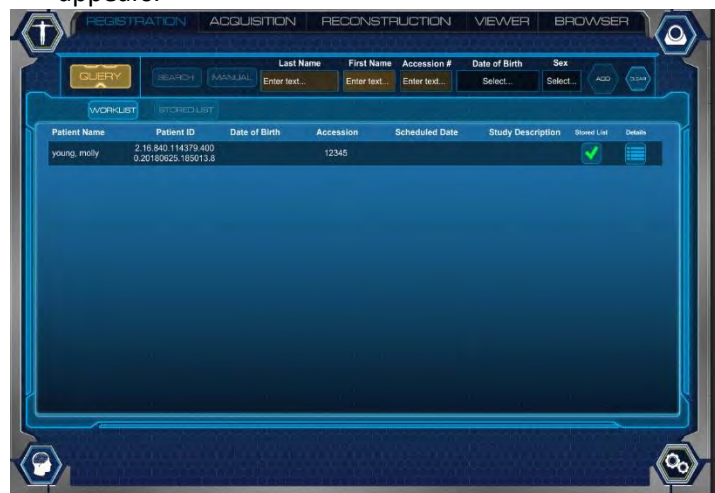

Figure 163: Query information dialog box

3. Select any of the named **Query Fields** you would like to use to query for patients by entering the value in the highlighted tabs.

A pop-up associated with the **Query Field** you are setting a value for appears. For example, if you press the **Scheduled Start Date** value row, the **Calendar** pop-up appears. Select the (new) date for the start. Another example would be to select the **Patient Name** value row. The **keyboard** pop-up appears so the user can type the patient's name to query.

The user can select any of the **Value** rows to fill in data to help query the patient you are searching. You can enter as much or as little information as needed. If no information is available, leave the value blank.

The screenshot displays a user interface for patient query. At the top, there are four input fields: 'Patient Name' (with 'Enter text...' placeholder), 'Patient ID' (with 'Enter text...' placeholder), 'Accession' (with 'Enter text...' placeholder), and 'Schedule Start Date' (with 'Select...' placeholder). A 'CLEAR' button is located to the right of these fields. Below the input fields is a table with columns: 'Birth', 'Accession', 'Scheduled Date', and 'Stu'. A date selection calendar is overlaid on the table, showing a grid of years from 2016 to 2031. The calendar has a title '2016 - 2031' and navigation arrows. The grid contains the following years:

2016	2017	2018	2019
2020	2021	2022	2023
2024	2025	2026	2027
2028	2029	2030	2031

At the bottom of the calendar, there are two buttons: a checkmark (✓) and an 'X'.

Figure 164: Query fields

- When you are finished filling in query selections, perform one of the following:
  - Press the **Search** button to query based on the newly entered data to help narrow down your search.
  - Press the **Clear** button to remove any changes and return to the previous **Query Information** pop-up.
- A list of patients matching your selected criteria variables populates in the Query Results list on the Registration tab.

Patient Name	Patient ID	Date of Birth	Accession	Scheduled Date	Study Description	Stored List	Details
Doe, John	73555624	1/1/2000	78502800	1/1/2000		<input checked="" type="checkbox"/>	
Doe, Jane	70116490	1/1/2000	78112788	1/1/2000		<input checked="" type="checkbox"/>	
Michaelson, Michael	28209051	1/1/2000	65356487	1/1/2000		<input checked="" type="checkbox"/>	
Johnson, John	12001598	1/1/2000	91207248	1/1/2000		<input checked="" type="checkbox"/>	
Smith, Bob	39096817	1/1/2000	84370865	1/1/2000		<input checked="" type="checkbox"/>	
Smith, Sally	10216957	1/1/2000	02402899	1/1/2000		<input checked="" type="checkbox"/>	
Smith, John	73339663	1/1/2000	09998005	1/1/2000		<input checked="" type="checkbox"/>	
Doe, James	80314585	1/1/2000	06970192	1/1/2000		<input checked="" type="checkbox"/>	
Robertson, Robert	96856234	1/1/2000	89459160	1/1/2000		<input checked="" type="checkbox"/>	

Figure 165: Registration query results table

6. Select a patient and select the **Register** button to register the patient for the exam.
7. The system enables and opens the **Acquisition** tab. To perform the acquisition steps, see “Performing A Scan” on page 171.

## Storing patients in the stored list

This list is helpful when multiple patients need to be scanned and connection to a worksite like **HIS/RIS** is unavailable at the exam location.

1. If necessary, go to the **Registration** tab to query the patients(s).
2. Perform steps 2 through 5 in “Querying patient information” on page 162.
3. Select the **Query** button.  
Let the criteria you selected populate into the **Query Results** list area.
4. Select one or more patient entries from the **Query Results** list.  
Select patients in the following ways:
  - To select one patient, press the **Stored** icon located on the right side of the registration screen.
  - To select more than one patient at a time, select the **Stored** icon for each patient you would like displayed in the stored list.
5. Select the **Stored** list.  
The patients and subsequent patient information you selected appear in the Stored Results list on the Registration screen.

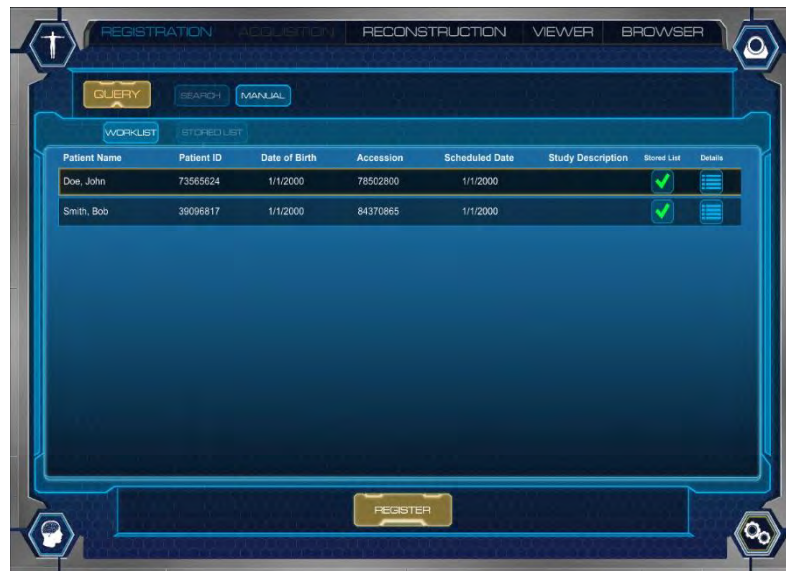

Figure 166: Registration stored results table

6. Select the patient you want to select from the **Stored Results** table.
7. Select the Register button to register the stored procedure in order to perform an examination.  
The system enables and opens the Acquisition tab, which is discussed in more detail later on in this user manual.

## Removing patients from the stored list

Patients can be manually deleted from the **Stored List** or if configured in Service, patients can automatically be removed from the stored list when the patient study is finalized. The pop up below will appear after finalizing a patient, if configured.

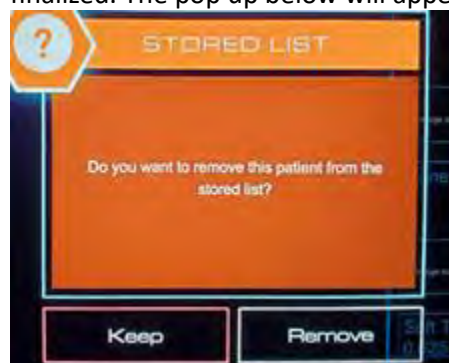

Figure 167: Stored list

## Manually registering a patient using 'Manual Add'

You manually register a patient for examination when the **HIS/RIS** server is unavailable, the patient cannot be found, and/or was never entered into the system.

1. If necessary, go to the **Registration** tab.
2. Press the **Manual Add** button.

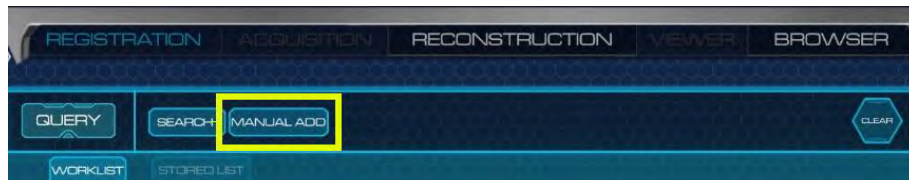

Figure 168: Manual Add button

3. The **Add Patient Info** dialog box appears.

Figure 169: Manually Add Pt Info Dialog Box

4. For **Patient Name**, press the **Patient Name** field.  
The **Keyboard** dialog box appears.
5. Enter patient name information in the fields provided and press the **Add** button to save your entries.  
Notice that the value appears with the last name first, separated by ^, the first name next, separated by ^, the middle name (if you supplied that information), and any other information you entered.
6. For the **Patient Date of Birth**, perform the following:
  - Press and hold the **Patient Date of Birth** field.
  - Enter the patient's birth date in the **Patient date of birth** field using the **Calendar** pop up.
  - Select the **Add** button to save your work.
7. For the **Patient's Sex**, perform the following:
  - Press and hold the Patient's Sex field.
  - A drop-down list will display:
    - Female
    - Male
    - Other
  - Select the **Patient's Sex** from the drop-down list and press the **Add** button to save your entries.
  - Select the Register button to register your patient data.  
When you press the **Register** button, the system enables and opens the Acquisition tab.

8. After your patient is registered, view the **Patient Exam Details** to ensure your data is correct by selecting the **View Details** button.

## Viewing patient information

This procedure lets you view (but not change) the patient's information.

1. If necessary, select the **Registration** tab on the main screen.
2. Select a patient from the **Query Results** list or the **Stored Results** list.
3. Press the **Details** button.
4. Review the patient's information.  
This pop-up presents static information that you cannot change.
5. Press the **Close** button to exit the **View Details Information** pop-up. The patients you selected in step 2 appear in the **Stored List**.

## Chapter 9 Patient Scanning

### Patient scanning overview

After registering the patient, the **Acquisition** tab is enabled and automatically opens. The **Acquisition** tab lets you check that the selected patient information is accurate before you perform the examination (scan). The **Acquisition** tab is also where you can set protocols for the scan before you scan the patient. A protocol lets you assess how you will capture the image you scan during the patient examination.



Figure 170: Active acquisition tab

After the protocol is selected, you can scan the patient by initiating the scan from the Tablet. See “Performing A Scan” on page 171.







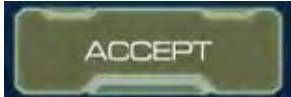

The following table provides information on the buttons on the **Acquisition** tab and what they are used for. Later you will learn how to set protocols for the scan.



**CAUTION** When conducting multiple or repeat scans, make sure the total exposure does not exceed maximum limit of 1Gy.

Table 42: Acquisition buttons

Acquisition buttons	Action
	Accepts the chosen protocol for the current study.

Acquisition buttons	Action
	Authorizes the scanner to move to the next step (if applicable).
	Begins the countdown on the LCD to perform the study.
	Allows the user to Pause the scan acquisition and then resume.
	Allows the user to repeat a portion or all of the scan.
	Allows the user to start the exposure when using the Step and Shoot option.
	Allows the protocol with Step and Shoot activated to resume the remainder of the acquisitions automatically.
	Allows the user to manually start the acquisition when doing CT Angiography protocols.
	Allows the user to cancel the scout or scan.
	Allows user to modify existing protocol selected in exam or choose a new protocol.

## Identifying protocol types

Protocol types identify how to capture an image during a scan. The following are protocol types you can select from.

## Axial

This protocol type lets you scan in **Transverse** plane. Data is acquired as the x-ray tube rotates around the patient.

## Helical

This protocol lets you acquire data continuously as the x-ray tube rotates around the patient; the scanner translates over the patient in the Z axis.

### Helical scan coverage

**Helical** scan coverage is typically truncated by 0.625cm to cover a half rotation at each end. “Figure 172: Scan coverage and imaged region for a true coverage of 60mm” shows the exposure using a radiographic film. The film shows exposure of the **Helical** scan-type coverage of 60mm. X-ray was on for 60mm. It took the scanner one extra second to completely stop after x-rays turned off. Figure 172 also shows exposure length to be 60mm.

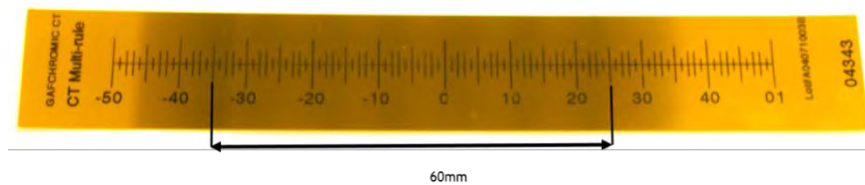

Figure 171: Radiographic film of the 60mm scan coverage

The number of 0.625mm slices generated is 49, which covers about 60mm. The scanner parallel images start at the laser location and end where the scan ends. “Figure 171: Radiographic film of the 60mm scan coverage” shows the scan markers as described above. For a typical **Helical** scan with 23cm coverage, excess dose is 5.4% of scan dose.

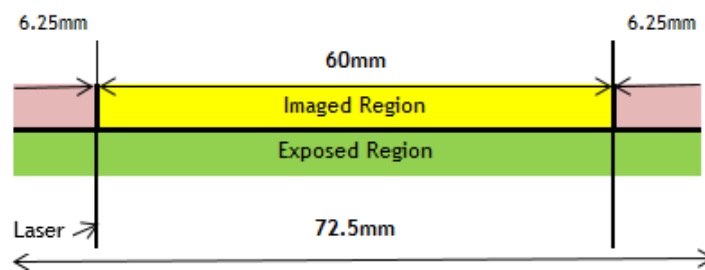

Figure 172: Scan coverage and imaged region for a true coverage of 60mm

## Reference

This protocol lets you acquire a single 10mm slice to review anatomical position or place the **Region of Interest (ROI)** for **Bolus Tracking** scans. **Reference** scanning can only be used in conjunction with **Helical** scanning during a CTA protocol or perfusion.

## Scout

This protocol lets you acquire data continuously as the x-ray tube remains stationary at a designated angle; the scanner translates over the patient in the Z axis. The resulting **2D** projection is used during examination planning.

---

### Performing a scan

You cannot complete this procedure without a registered patient.

**Note:** If the scan needs to be stopped, perform the following:

**For an immediate or hard stop**, press the **E-STOP** button. This stops x-ray, translate movement, and gantry rotation immediately.

**For a controlled stop**, press the **Cancel** button.

- From the Tablet, go to the **Registration** tab to assign the patient to the scan in one of the following ways:
  - Query an already existing patient from the **HIS/RIS**.
  - Manually register the patient.
 The **Acquisition** tab will be activated when the patient is registered.
- From the **Acquisition** tab, select either **Adult** or **Pediatric** patient type to match the patient's age.

<b>Adult</b>	To scan adult patients. Set adult protocols are stored by anatomical area, here.
<b>Pediatric</b>	To scan pediatric patients. Set pediatric protocols are stored by anatomical area.

By selecting either an **Adult** or **Pediatric** patient, the corresponding list of saved protocols becomes available.

**Note:** Adult and pediatric protocol parameters are customized to meet your requirements in conjunction with local and nationally recognized published guidelines. These protocols **must be** approved by your facility physicist **before** the system's acceptance.

- Select the desired protocol from the list.
- Select the **Accept** button to review the selected protocol.



Figure 173: Illuminated accept icon

5. The **Exam Planner** dialog box appears.



Figure 174: Exam planner dialog box

The **Protocol Information** tabs displayed on the left and **Protocol's Series** boxes displayed on the right show the series that are already created. The **Patient Position** is chosen before a protocol is selected and displays the same for both adult and pediatric patients.

**Note:** You can modify a protocol; however, changes you make from **Acquisition** will not be saved permanently. Permanent changes to protocols can only be made by the administrator in Protocol Manager.

Assuming you have the proper user privileges, you can modify protocol parameters such as, kV, mA, and coverage at the time of the scan, but the modifications will not be saved for future use.

6. To edit an existing protocol, perform the following:

- Select an existing protocol series by pressing into the area within the box.
- The selected **Protocol Series** will display.
- Enter a description and make any other appropriate changes for your protocol.
- Select the **Update** button in the **Protocol dialog** box.
- Alternatively, select the **Select Protocol** button to return to the **Exam Planner**.



Figure 175: Protocol series dialog box

7. Set up the patient and scanner.
  - See “Positioning the patient” on page 78.
8. On the **LCD Touch Screen** on the scanner, press the **Laser** button to turn on the laser.
9. Move scanner and align patient as needed.
10. Select **Begin** on the Tablet from the **Exam Planner** dialog box.
11. The **Ready. Press ‘Scan’ on scanner** pop-up appears.



Figure 176: Ready, press 'scan' on scanner

12. Press **Scan** from the LCD touch screen to acquire your scout(s) and/or scan.

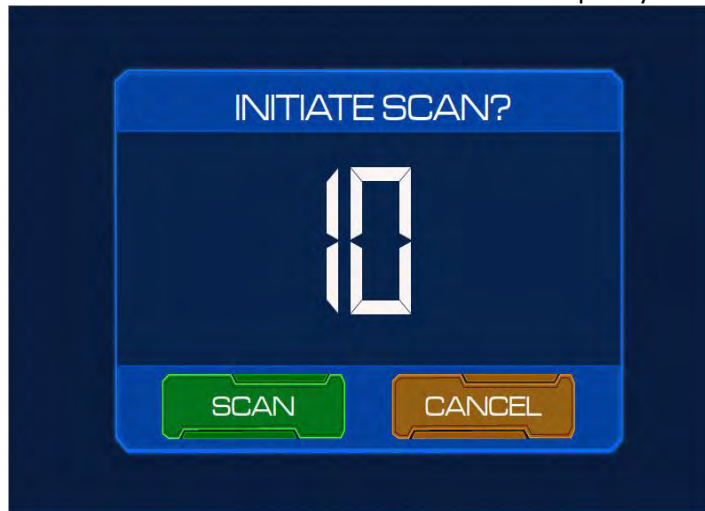

Figure 177: Initiate scan on LCD

**Note:** During the scan, observe the following:

A yellow light on top of the scanner indicates x-rays are emitted; an audible beep identifies that radiation is being emitted.

The scanner translates away from the patient.

13. After Scout is acquired, parameters can be set on the scout.

- Scan parameters (start and end locations) can be modified by pressing and dragging the box in the upper, right corner of the scout.
- You can also center the **Field of View** by selecting the circle and dragging it to the desired location.



Figure 178: Setting scout parameters

14. Select the **Continue** button (on the Tablet) to acquire the scan or press the **Cancel** button to cancel the scan.

15. The **Ready, Press 'Scan' on scanner** pop-up appears again.



Figure 179: Ready, press 'scan' on scanner

16. Go to the scanner and press the **Scan** button to initiate the scan.

**Note:** The patient's scan results appear ~ 16 images per second.

17. After the scan, you can review your images in the **Acquisition** tab.

18. Perform manual or attached reconstructions.

19. When the scan is complete the **Complete** dialog box will pop-up. Select **Yes** finalize the patient and generate the **Dose Report**.

- Selecting **No** will return you to the **Scan Complete** screen and would allow you to Repeat a scan or select a new protocol and continue scanning.
- To **Finalize** the patient after pressing **No** on the **Complete** dialog box and generate the **Dose Report**, select the **Patient Icon**, then select **Finalize**.

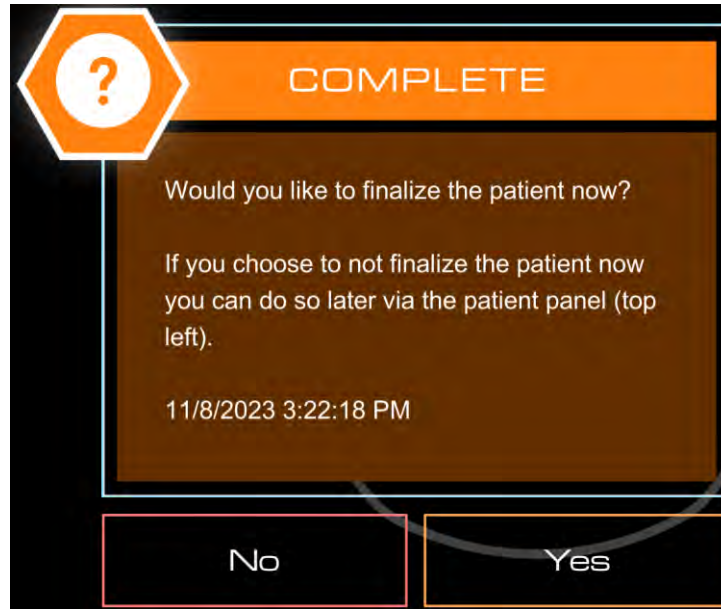

Figure 180: Complete dialog box

**Note:** You must press the **Finalize** button before you can send the patient's data to PACS.

## Re-using Scouts with a New Protocol

1. Following the scan, select the **Protocol** button on the acquisition screen.



Figure 181: Scan Complete

2. Select the **Start New** button.

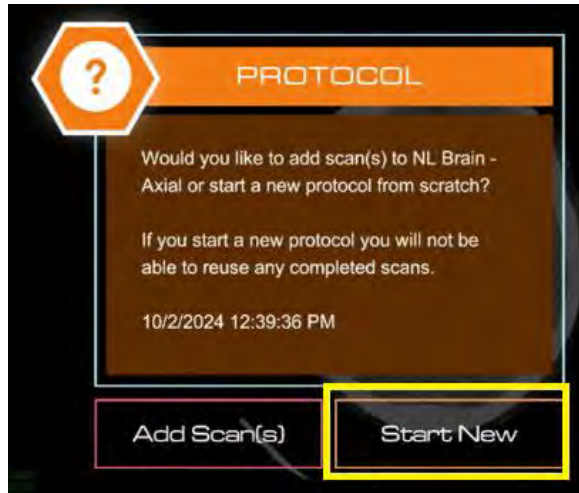

Figure 182: Start New

3. Select “Yes” to Re-use the Scout



Figure 183: Reuse Scout

4. Select new protocol and tap **Accept** button



Figure 184: Accept new protocol

5. Review Scout and scan parameters and select **Begin**.



Figure 185: Begin

- Reset scout parameters, if needed, and select **Continue** to acquire the new scan.



Figure 186: Reused Scout

## Repeating an Image

The repeat function can be used to repeat a scan if necessary. The entire scan can be repeated, or after reviewing the images, a new start position and coverage can be selected if only a portion of the scan needs to be repeated.

- While the **Acquisition** tab remains active (before finalizing), click the **Repeat** button.
- The **Repeat Protocol** pop-up appears.
- Review the repeat scan coverage parameters.



Figure 187: Repeat scan pop up

**Note:** You can change the start position and coverage or use what appears.

4. Click the **Repeat** button, on the **Repeat Scan** pop-up.
  - The scanner will move to the start position.
5. Press the **SCAN** button on the scanner's control panel to begin the repeat scan.

---

## Scanning with special features

The following features are available for use in protocols.

### Using the step & shoot option

The **Step & Shoot** option in the protocol lets the user control the start of the scan acquisition. This is helpful in the case of an uncooperative or ill patient where motion is an issue.

1. If necessary, change the Scan Type to Axial.
2. Enable Step and Shoot by selecting the **Step & Shoot** button located in Options in the protocol.



Figure 188: Step & Shoot dialog box

3. Select the check mark to save Step & Shoot setting.
4. Select **Update**.
5. Make sure your patient and scanner are positioned.
6. Press the **Begin** button to begin the scan.
7. The **System 'Ready' to Scan** message will appear.
8. Go to the scanner and press the **Scan** button on the **LCD Touch Screen**.
  - The first set of images are acquired at this position.
9. Press the **Initiate Exposure** button to initiate the next acquisition. To cancel the scan, select the **Cancel** button.
10. **Resume All** will turn off manual control of exposures and resume scanning automatically.

## Performing a scan with Automatic Exposure Control (AEC)

**Computed Tomography (CT)** is responsible for the largest contribution to the collective effective dose to patients in radiology. The challenge to radiologists and medical physicists is to establish adequate image quality with the lowest radiation exposure to the patient.

**Tube current (mA)** is one of the key technical scanning parameters for adjusting radiation dose in CT. To optimize radiation dose in CT, users can adjust mA either with manually selected values or with the application of Automatic Exposure Control (AEC). **AEC** refers to the automatic adaptation of mA on the basis of user specified image quality and attenuation characteristics of the scanned body region.

In OmniTom Elite, scout scans provide a graph of mA values based on object density and desired noise level. A single Axial or Helical scan in the protocol can utilize AEC, limiting the mA value of each slice to the minimum necessary to achieve the desired image quality. This ability to modulate the mA throughout the scan to achieve the desired noise level can reduce patient dose.

When using AEC, it is vitally important that the patient is well-centered in the gantry. AEC aims to deliver the specified image quality across a range of patient sizes. The use of

AEC may change the planned  $CTDI_{vol}$  and DLP values. It tends to increase  $CTDI_{vol}$  for large patients and decrease it for small patients relative to a reference patient size stored in the scanner.

**Note:** Ensure patient is accurately centered in gantry. Do not use AEC when any type of metal is going to be scanned.  
Do not use **AEC** with a small FOV; that is; tiny neonatal patients.  
An automatic adjustment of the tube's current cannot occur when the tube potential is changed.  
**AEC** can only be used with the Posterior Fossa kernel.

1. Enable **AEC** by selecting the **ENABLE AEC** button located in **Options** in the protocol.



Figure 189: Options dialog box with AEC enabled

2. Select the **Minimum mA** dropdown to set the minimum allowed mA value to be used for scanning.
3. Select the **Maximum mA** dropdown to set the maximum allowed mA value to be used for scanning. The available mA range is 2.5 to 45.
4. Select the **Noise Level**- to set the standard deviation of the noise value for the acquired images. The available noise range is 1-200.
5. Select the check mark to save **AEC** settings.
6. Select **Update**.
7. Make sure the patient and scanner are positioned, and the patient is centered.
8. Select the **Begin** button to begin the scan.
9. Press **Scan** from the **LCD touch screen**.
10. After the scout(s) are acquired and the scan region is set, select the **Toggle AEC Graph Icon**.



Figure 190: Toggle AEC graph icon

- The **AEC Graph** will be displayed on the scout. Review the mA modulation to ensure it meets your clinical needs.

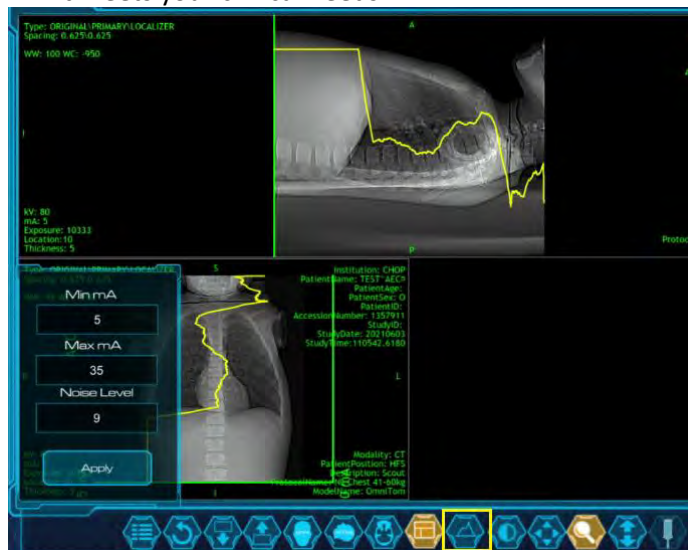

Figure 191: AEC graph

- To return to the scout parameter view, select the **Toggle AEC Graph Icon** again.
- If the desired level is achieved according to your department policy, select the **Continue** button.
- Press **Scan** from the LCD.

**Note:** While reviewing the scan you will see mA modulation as per your graphs.

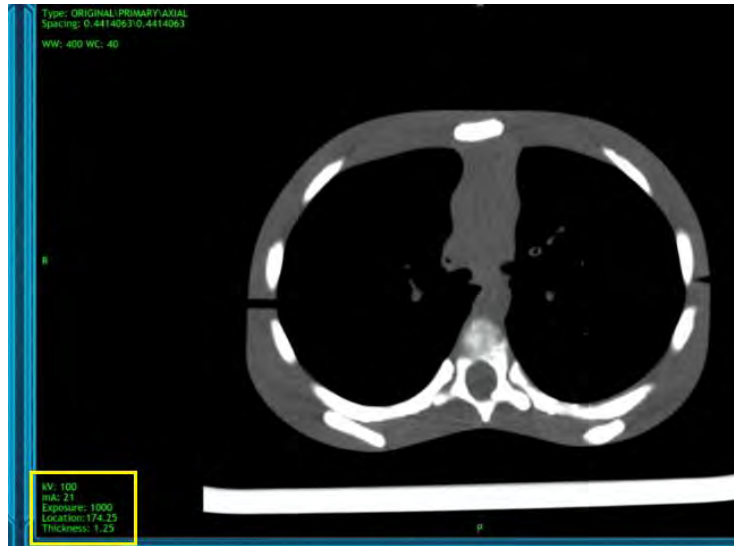

Figure 192: mA modulation

## Adding Noise Reduction to Axial Reconstructions

1. Enable **Noise Reduction** by selecting the **Options** button in the protocol.

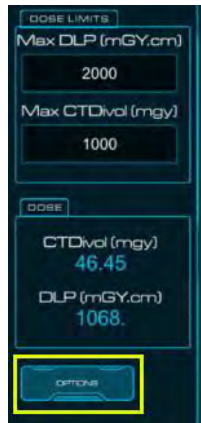

Figure 193: Options

2. Select **Noise Reduction**



Figure 194: Noise Reduction

3. Select the desired level of **Noise Reduction**



Figure 195: Noise Reduction Levels

4. Select the **Check Mark** to save your selection.



Figure 196: Save

**Note:** Noise Reduction is **only** available for protocols using the Axial scan mode.

## Performing a CT angiography scan with bolus tracking

CT angiography is a technique that uses contrast to visualize arterial and venous vessels throughout the body. This ranges from arteries serving the brain to those bringing blood to the lungs, kidneys, arms, and legs.

1. Perform steps 1 through 6 in “Performing a scan” on page 171, selecting your approved CTA protocol.

**Note:** Adult and pediatric protocol parameters are customized to meet your requirements in conjunction with local and nationally recognized published guidelines. These protocols **must be** approved by your facility physicist **before** the system’s acceptance.



2. After selecting a CTA protocol, review Dynamic CTA options including **Delay, Bolus Mode, Contrast Threshold, Duration, and Injector Start** and make your selections.



Figure 197: Dynamic-CTA options

The following table explains the bolus tracking parameters and icons:

Table 43: Bolus tracking icons

Bolus Tracking Icons	Description
	The amount of time allowed to monitor the bolus
	Begins the scan after the specified bolus scan time if no bolus is detected
	Stops the scan after the specified bolus scan time if no contrast is detected

<b>TestBolus</b>	A small amount of contrast is injected, and a timing graph is given after specified bolus scan time
<b>Contrast Threshold</b>	Hounsfield Unit detection at area being monitored - ROI
<b>Manual</b>	Manual Injector Start. The user is required to manually start both the scanner and the injector
<b>Auto</b>	Auto Injector Start. The scanner and injector will start when pressing start from injector

3. Perform scout(s) and set parameters.



Figure 198: Parameters on scout

4. The series boxes below show the steps in the CTA process.

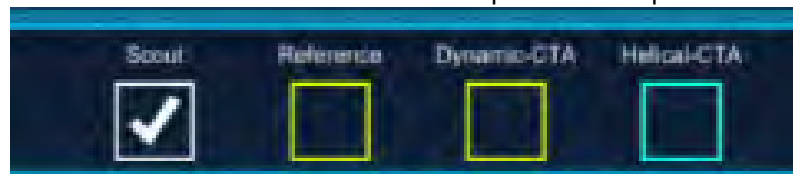

Figure 199: Series boxes

5. To move the scout or reference parameter, select the appropriate series box to activate the scan region

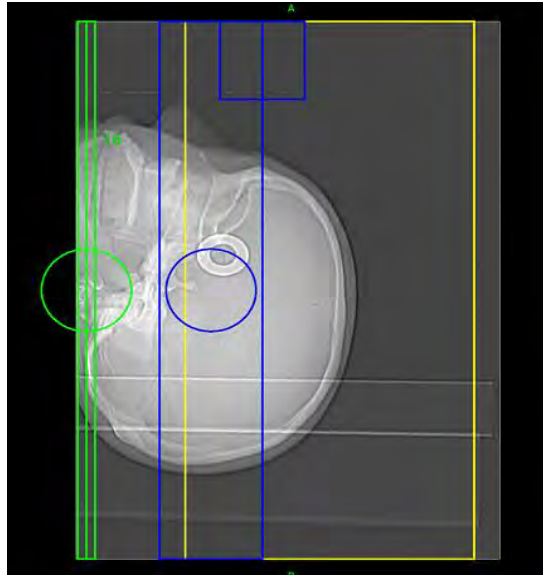

Figure 200: Active scan regions on scout

6. Select **Continue** to acquire a Reference Scan.

**Note:** A Reference scan is a single 10mm slice at a prescribed location. The Dynamic CTA is a monitoring scan and will be performed at the same location as the Reference scan.

7. Select the **Bolus ROI** tool.
8. Draw the ROI at the region you wish to monitor the bolus.

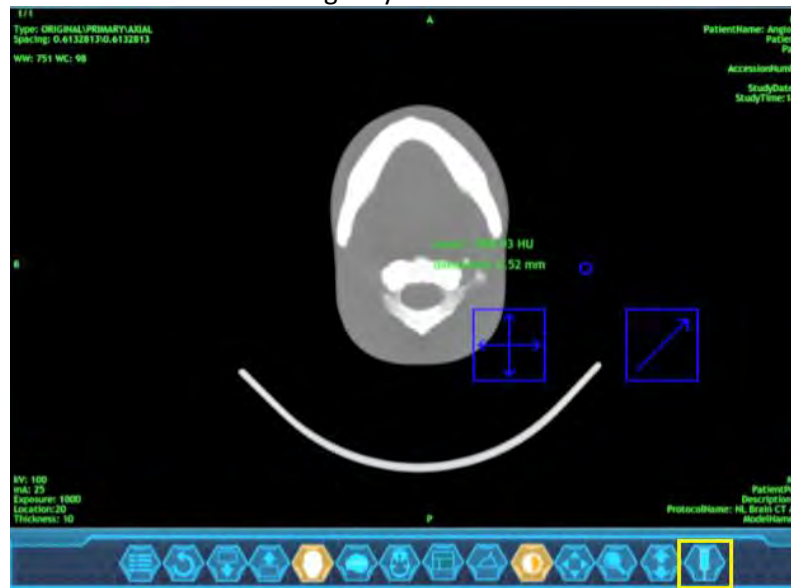

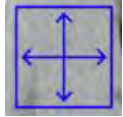
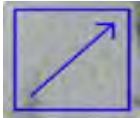

Figure 201: Bolus ROI

Table 44: Bolus tracking tool table

Bolus Tracking Tool	Description
	Bolus ROI Tool
	Moves Bolus ROI location
	Resizes Bolus ROI

9. Select **Continue**.
10. Load the injector and set the desired amount of contrast flow rate.
11. When the scanner is ready, press **Start** and manually start the injector at the same time, if you have chosen the **Manual Injector Start** option. If you have selected the **Auto Injector Start** option, press **Start** on the injector only.

**Note:** The Auto Injector Start is a purchasable option for the OmniTom Elite. Please contact your Customer Service Representative to purchase.

12. Scanner will trigger when bolus enters the reference point/Bolus ROI.

**Note:** During the Dynamic-CTA scan, if the Contrast Threshold is not reached, you can manually trigger the Helical CTA scan by clicking **Manual Start**.

13. Review completed scan.

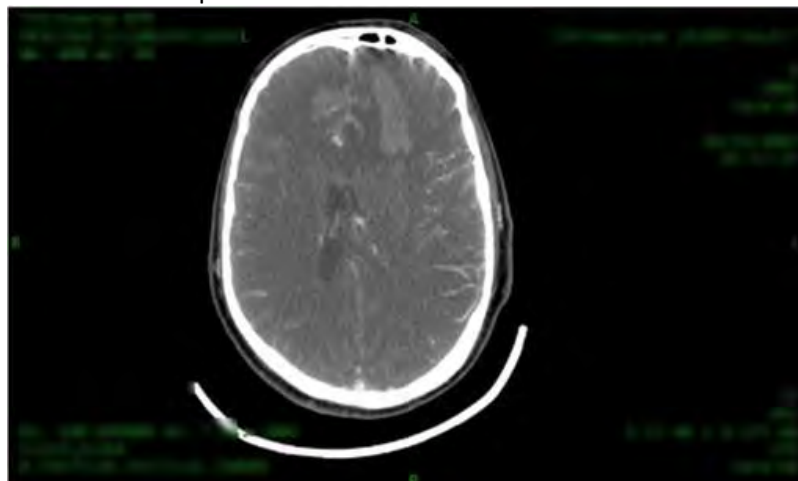

Figure 202: Completed CTA

14. Select **Finalize** and perform reconstructions and MPRs as needed.

## Performing test bolus

**Test Bolus** tests the timing of the contrast injected.

A small amount of contrast is injected, and a timing graph is given after the specified bolus scan time. When the contrast is detected, the system stops scanning and a report on the recommended delay time appears.

1. Select **Test Bolus** under the Bolus Mode options in the Dynamic CTA protocol.
2. Review Duration to determine length of **Test Bolus** monitoring time.
3. Select **Update**.
4. Select **Begin** to acquire the scout(s) and reference scan.
5. When the scanner is ready select **Start** on the scanner LCD.
6. Perform scout(s) and set parameters.

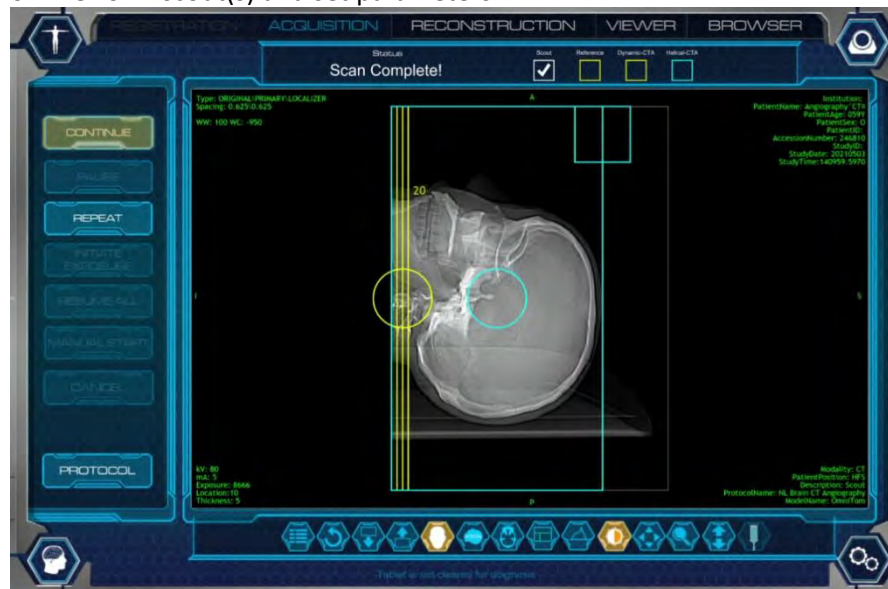

Figure 203: Parameters on scouts

7. Select Continue to acquire a Reference scan.

**Note:** A Reference scan is a single 10mm slice at a prescribed location. The Dynamic CTA is a monitoring scan and will be performed at the same location as the Reference scan.

8. Select the **Bolus ROI** tool.
9. Draw the **Bolus ROI**.
10. Select **Continue** to begin Test Bolus.

11. Load the injector and set your desired amount of contrast (typically 10ml) and flow rate.
12. If you have chosen the **Manual Injector Start** option, once the scanner is ready, press **Start** on the scanner and injector at the same time. If you have selected the **Auto Injector Start** option, press Start on the injector only.

**Note:** The Test Bolus graph will appear at the end of the prescribed duration time, showing the bolus tracking time. The recommended Scan Delay time for the CTA protocol will be displayed, as shown below in Blue.

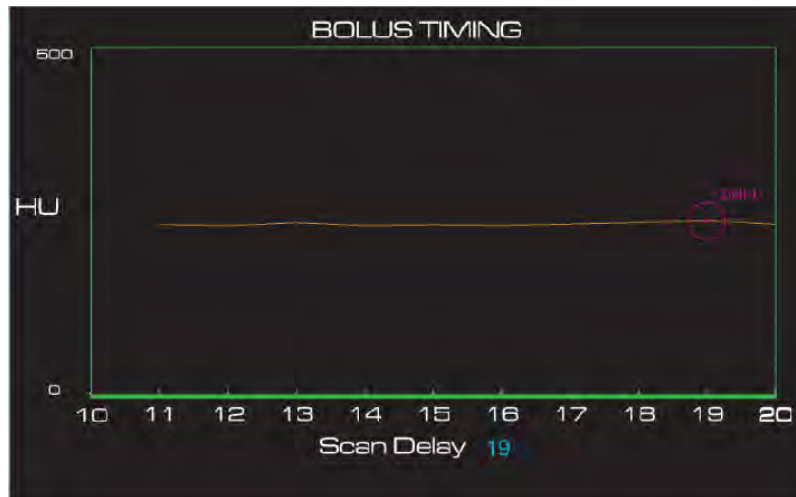

Figure 204: Bolus timing graph

13. Select **Continue** to perform the scan with appropriate **Scan Delay**.
14. Review completed scan.
15. Select **Finalize** to complete.

## Performing a CT perfusion scan

CT Perfusion (CTP) is a technique used to evaluate cerebral perfusion or the level of blood flow in the brain by monitoring the initial passing of iodinated contrast media through the vasculature of the brain.

1. Perform steps 1 through 6 in "Performing a scan" on page 171, selecting your approved CTP protocol.
2. After selecting CTP protocol, review Dynamic CTP options including **Duration** and **Injector Start** and make your selections.



Figure 205: CT perfusion dynamic scan options

### 3. Perform scout and set dynamic CTP scan location.

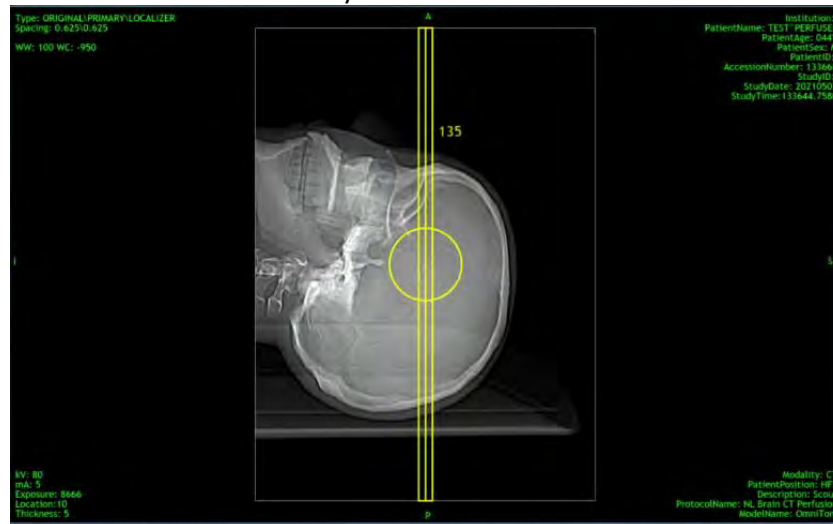

Figure 206: Set dynamic CTP scan location

4. To move the Dynamic CTP location, move the yellow line using the circle on the reference line.
5. Select **Continue** to acquire the reference scan.
6. Load the injector and set your desired flow and rate. When the scanner is ready, press Start and manually start the injector at the same time, if you have chosen the **Manual Injector Start** option. If you have selected the **Auto Injector Start** option, press Start on the injector only.
7. Review completed scan.

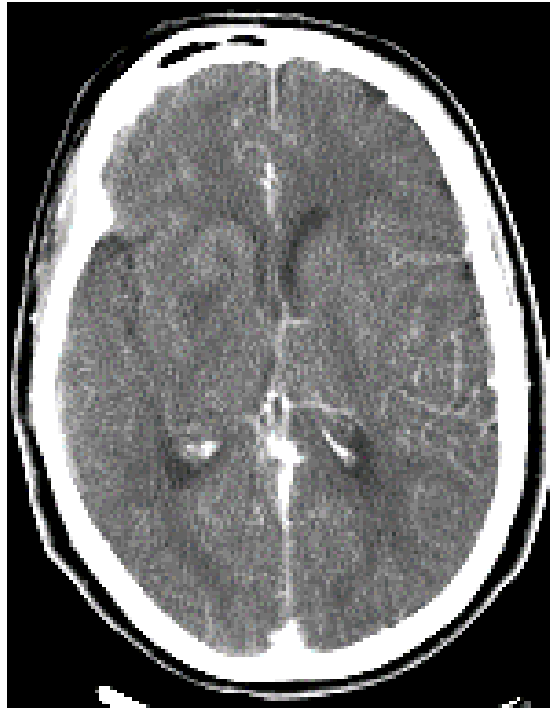







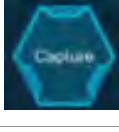







Figure 207: Review completed scan

8. Select Finalize.

### Viewing images in the CTP viewer

Table 45: CTP Viewer Tools

CTP Viewer Tools	Description
	Select to place the arterial and venous ROIs on the image
	Hides the arterial ROI
	Hides the venous ROI
	Select to calculate the CT Perfusion maps

	Blends the original scan with the perfusion maps
	Reset
	Captures a screenshot of the maps
	Shows a graph of the arterial and venous blood flow
	Changes the layout of the screen
	Allows the user to scroll through the images with their finger
	Brightness/Contrast
	Zoom
	Pan
	Scroll Up through images
	Scroll down through images

## Examining the scanned image with tools

You cannot work with image tools without a registered patient, the **Acquisition** tab enabled, and a scanned image showing. You can also use image tools from the **Viewer** tab – after you select a patient and open the associated images. In either case (from the **Acquisition** or the **Viewer** tab), the tools appear at the bottom of the screen and will illuminate when selected.

From the **Acquisition tab**, you can zoom, pan, modify window width, window level, and change layout; see the table below to understand the basics of what each tool looks like and how it performs.

## Using tools on the acquisition tab

The following table describes some of the tools available to you when the **Acquisition** tab is active. For a comprehensive list, see [Table 46](#).

Table 46: Image tools





Image tool	Tool name	Action
	<b>Preset</b>	Pre-defined Window Width and Window Level settings are located in a dropdown. Width and level presets can be saved or deleted by an administrator.
	<b>Reset</b>	Reverts all images back to their original mode.
	<b>Page Down</b>	Press and hold to page down through the images.
	<b>Page Up</b>	Press and hold to page up through the images.
	<b>Toggle AP/PA</b>	Displays scouts from <b>Acquisition</b> .









Image tool	Tool name	Action
	<b>Toggle Lateral</b>	Displays scouts from <b>Acquisition</b> .
	<b>Toggle CT</b>	Displays Axial or Helical scan from <b>Acquisition</b> .
	<b>3 Panel Viewer</b>	Displays Scout(s) and scan from <b>Acquisition</b> simultaneously.
	<b>Toggle AEC Graph</b>	Allows you to automatically adapt the tube current or tube potential according to the patient's body habitus in order to achieve the specified image quality at the lowest possible dose. AEC must be enabled in the protocol prior to the scan to use graph.
	<b>Window Width &amp; Level</b>	After selecting tool, press and drag in chosen direction to adjust image width and level.
	<b>Pan</b>	Allows you to move the image on the screen.
	<b>Zoom</b>	After selecting tool, press and move in upward direction to zoom in (enlarge) and downward to zoom out (shrink).
	<b>Scroll</b>	Allows the user to scroll through images slowly by dragging along the tablet surface.

Image tool	Tool name	Action
 The icon shows a blue, glowing, hexagonal shape with a central vertical bar, representing a bolus ROI.	<b>Bolus ROI</b>	Allows the user to draw the ROI for use with bolus tracking.

## Chapter 10 Browser

### Browser overview







The **Browser** lets you view patient information and images associated with the patient information – after the patient’s scan.



Figure 208: Active browser tab

The following table identifies the buttons found on the **Browser**.

Table 47: Command buttons

Button	Action
	Allows you to Edit Patient Details prior to sending to PACS.
	Selects the exam you want to archive.
	Selects the exam you want to delete.
	Allows you to compare two series of images by tapping the compare arrow on each series you wish to compare.
	Selects the archive destination for selected information.
	Deletes the selected exam information from the <b>Browser</b> tab.
	Allows the user to preview the selected exam information before being archived or deleted.

## Navigating the browser

The Browser lets you perform tasks on existing series, for example archiving and previewing the series. This section will introduce you to the **Browser** and identify the symbols, areas, and buttons you can use.

The **Browser** can be broken down into the following sections:

- Studies Table
- Series Table

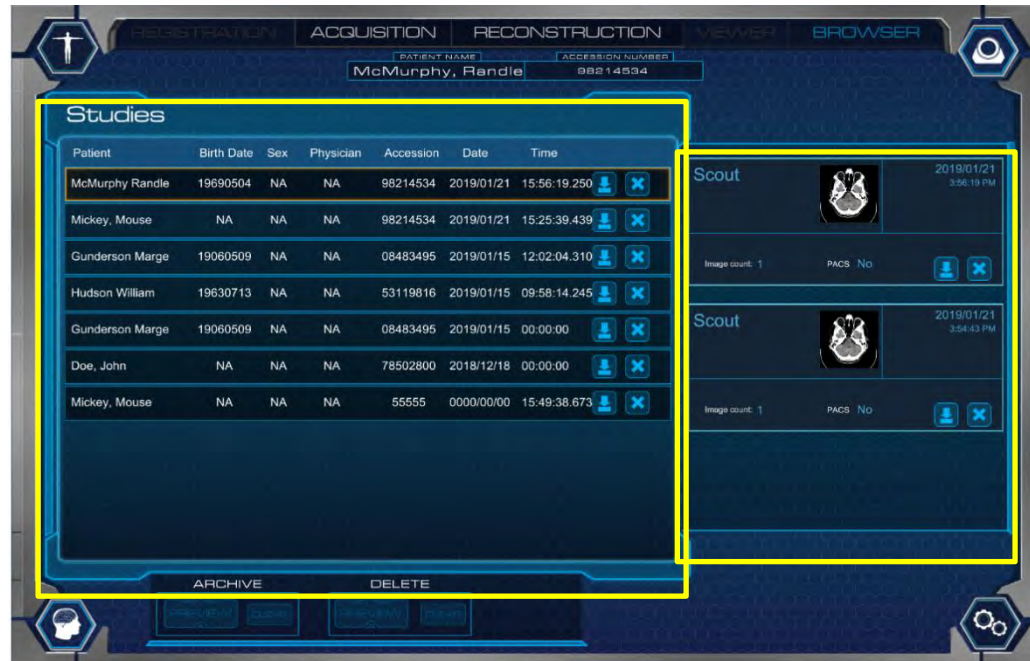

Figure 209: Browser studies and series tables

## Compare Series

1. Select the **Browser** tab, if necessary.
2. Select the desired patient from the **Studies Table**.
3. In the **Series Table**, select the **Compare Arrow** for the first series to compare, then select the **Compare Arrow** for the second series.

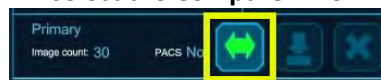

Figure 210: Compare Series Arrow

4. The **Viewer** will display the two selected series side by side.



Figure 211: Compare Series Viewer

5. The active series is highlighted with a green border and can be changed by tapping the image.
6. Each series of images can be manipulated independently of the other using the image viewing tools.
7. The **Series Left** and **Series Right** buttons on the right side of the user interface can be used to select a different series from the study to display in that window.



Figure 212: Series Selection Buttons

8. When the **Series Left** or **Series Right** buttons are activated a dropdown menu appears in the selected series in the **Viewer** allowing selection of any additional series of images in that study.

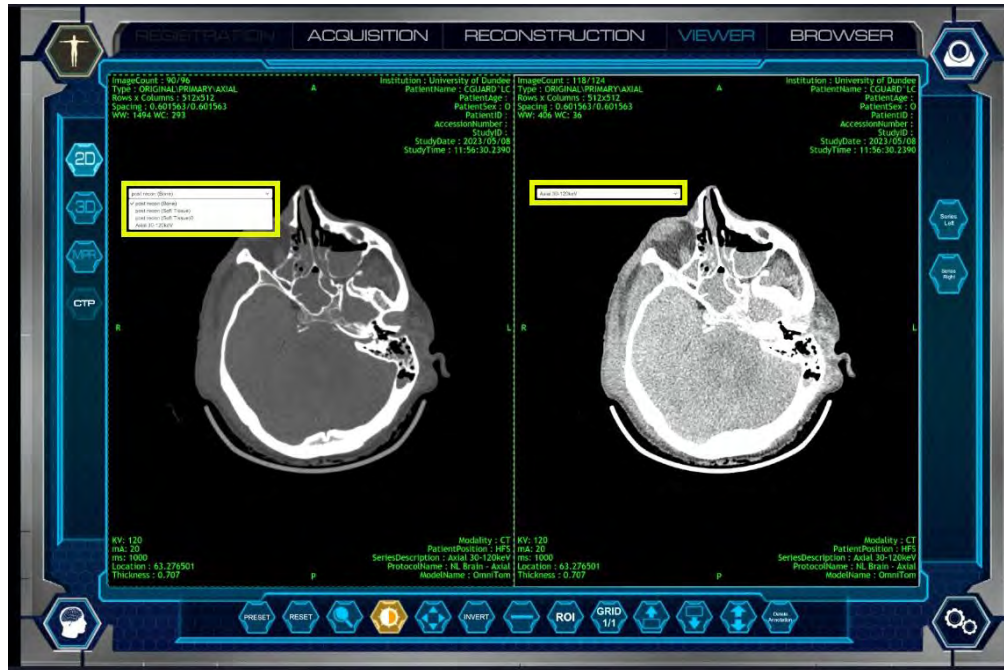

Figure 213: Series Selection Dropdowns

## Loading a series to viewer from the browser

1. Select the **Browser** tab, if necessary.
2. Select the desired patient from the **Studies Table**.
3. Select the desired series from the **Series Table**.
4. The selected series will autoload to the **Viewer** tab in **2D**.



Figure 214: 2D viewer

---

## Deleting a series

1. If necessary, tap the **Browser** tab.
2. Select the study or the series to delete by pressing the **Delete Icon** located on the right side of the series or study.
3. The Delete **Preview** and **Clear** buttons will illuminate.



Figure 215: Delete pop up

4. Choose from the following:
  - Select **Preview** to review the study or series to be deleted.
  - Select **Clear** to deselect the study or series.
5. After selecting **Preview**, choose from the following:
  - Select **Delete** to delete study or series.
  - Select **Cancel** to keep the study or series.

**Note:** It is recommended to always archive to PACS prior to deleting from the browser.

---

## Editing patient details

You can edit patient details in the browser prior to sending the data to PACS.

1. If necessary, select the **Browser** tab.
2. Select the patient in the Studies section
3. Select the Edit Patient Details icon. The Edit Details pop up will appear as shown below.



Figure 216: Edit patient details

4. Edit patient details as needed.
5. Select **Enter** to save or **Cancel**, if needed.
6. All series data will be updated.

---

## Archiving patient images

You can archive patients and studies (or series) to **PACS**.

## Archiving to PACS

1. If necessary, select the **Browser** tab.
2. Select the patient study for **PACS** in the following way:
  - To select one patient and all associated series select the **Archive** icon from the **Study** Table.
  - To select specific series for a patient, select the **Archive** icon for each individual series from the **Series** Table.
  - The Archive **Preview** and **Clear** Buttons will illuminate.



Figure 217: Archive pop up

3. Choose from the following:
  - Select **Preview** to review the study or series to be archived.
  - Select **Clear** to deselect the study or series.
4. Select the PACS Server you wish to send to. You can have multiple servers configured.



Figure 218 Select the PACS server

5. After selecting the PACS Server, choose from the following:
  - Select **Archive** to archive study or series.
  - Select **Cancel** to keep study or series from being archived to PACS.
6. Click the **Archive** button to begin the archive process.
  - To verify the status of your image transfer, select **System**, then select **PACS Queue**. The **PACS Queue** dialog box will appear to show the status of your image transfer.
7. Watch the status of each series:
  - **Connecting** informs you that the series is in the process of archiving to its targeted location. Each series will move from the top portion of the pop-up to the bottom portion of the **PACS Queue** pop-up when it has been processed.
8. If the series is not successfully stored to its targeted destination, the “Store Failed” message appears in the **Failure** column. This means the series was not successfully archived. If the series was successfully archived, no message appears in the **Failure** column.



Figure 219: PACS queue dialog box



If the job is sent successfully, the series disappears from the queue.

**Note:** Any **Storing Failure** status appears as a pop-up to inform you why the failure occurred. If an archive job fails, it will be sent to the **Failures** list.

9. When the archiving is complete, click the **Close** button to exit the **PACS Queue**.
  - You can also click the **Close** button, and the archiving process will continue as you do other tasks.

**Note:** While the archive is in process, you can perform one of the following from the buttons in the PACS Queue dialog box. See the table below for a description of the buttons and their actions.

Table 48: Store/print queue buttons

Store and Print Queue button	Action
	Shows the user the series that failed to archive. Select the Active button to return to the previous screen.
	Allows the user to Retry when an export fails.
	Shows the user the PACS Queue.

Store and Print Queue button	Action
	Closes the <b>Store/Print Queue</b> pop-up.

### MSU Image Transfer to Hospital

The following diagram illustrates the flow of images from the OmniTom Elite scanner on the MSU to the Hospital where the images are interpreted.

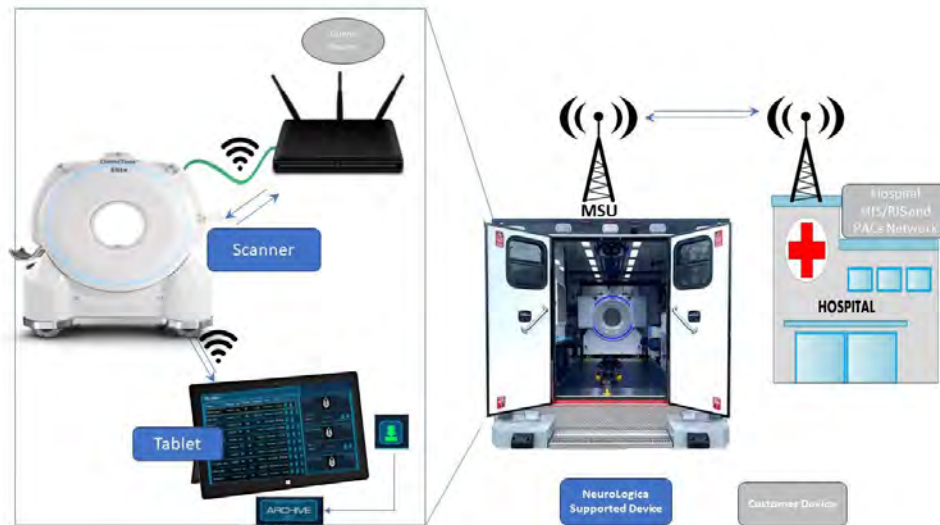

Figure 220: MSU Image Transfer to Hospital

Reconstructed images from the scanner are archived using the tablet. When the selected images are archived, the image files are sent through a Router in the MSU to the hospital network via wireless signal and into the hospital’s HIS/RIS or PACS network.

## Chapter 11 Viewer

### Viewer overview







The **Viewer** lets you see already scanned images from previous examinations. To view images, select the patient in **Browser** and then select the series to autoload to **Viewer**.



Figure 221: Active viewer tab

The following table identifies the image tools from the **Viewing** tab that let you manipulate a scanned image. To see the following image tools, the **Viewing** tab must be enabled and open. Some image tools appear on specific viewing tabs, only. The view tabs are 2D, MPR, and 3D.

Table 49: Common tools

Image tools	Tool name	Action
	<b>Preset</b>	Changes Window Width/Level also includes presets of common WW/WL.
	<b>Reset</b>	Reverts all images back to their original mode.
	<b>Zoom</b>	Magnifies the image.
	<b>Windowing</b>	Adjusts window width and center of image. This icon remains active.
	<b>Pan</b>	Adjusts image on X or Y axis.
	<b>Invert</b>	Inverts black to white and white to black.









	<b>Line</b>	Draws a line on the image and is used for measurement.
	<b>Region of Interest (ROI)</b>	Defines a circular <b>ROI</b> and displays the <b>ROI</b> information.
	<b>ROI Radius</b>	Allows you to type in a value for the placed ROI
	<b>Grid</b>	Toggles layout from a 1 x 1 grid to 2 x 2 grid when selected.
	<b>Page Up</b>	Press and hold to page up through the images.
	<b>Page Down</b>	Press and down to page down through the images.
	<b>Scroll</b>	Press and hold to scroll up or down through the images.
	<b>Delete Annotation</b>	Select to delete individual annotations.

Table 50: MPR tools

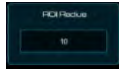







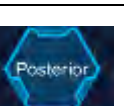



Image tools	Tool name	Action
	<b>Enable Slab</b>	Enables slab lines on the anatomy.
	<b>Slab</b>	Allows you to change the Slab Thickness, Spacing and Rendering mode of the MPR series.
	<b>Tilt</b>	When selected a White 'steering' wheel allows you to correct a rotated image.
	<b>Capture</b>	Allows you to set WW/WL, enter a Series name and save the MPR series.

Table 51: 3D tools

Image tools	Tool name	Action
	<b>Render Mode</b>	Displays the image in Color, MIP, or Grayscale.
	<b>Reset Orientation</b>	Resets the image to the acquired orientation.
	<b>Rotate</b>	Rotates the image.
	<b>Anterior</b>	Displays 3D image from the anterior view.
	<b>Posterior</b>	Displays 3D image from the posterior view.

	<b>Inferior</b>	Displays 3D image from the inferior view.
	<b>Superior</b>	Displays 3D image from the superior view.
	<b>Left</b>	Displays 3D image to the left.
	<b>Right</b>	Displays 3D image to the right.

## Setting window width and center

**Note:** Any modifications you make are not saved to the image.

1. Select a patient from **Browser**, select the series to view.
2. To open the image, click the **Viewer** button.  
The **Viewing** tab is enabled and open.
3. Click the **2D**, **3D**, **MPR**, or **CTP Viewer**.



Figure 222: 2D, 3D, MPR, and CTP viewing tab

To adjust the window width and/or level of the image, choose from the following options:

- To adjust with a preset, click the **Preset** button and select a preset: Abdomen, Angio, Bone, Brain, Chest, and Lungs.

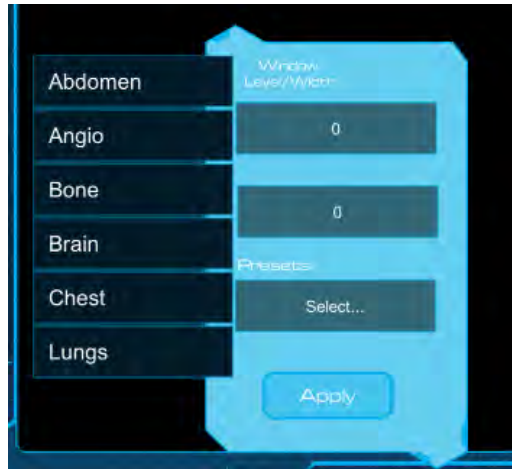

Figure 223: Windowing preset list, text boxes, and the apply button

- To adjust the windowing width and level with the text boxes, enter the width and level values in the **Width** and **Level** text boxes, and click the **Apply** button.

## Viewing images in 2D

**2D** lets you view scanned images in a **2-Dimensional (2D)** space. Standard **2D** mode is used when *only* one dataset is loaded. The default layout is a 1 x 1 grid.

**Note:** Any modifications you make are not saved to the image.

The **Viewer** tab is active immediately following acquisition. The current exam will autoload into the **Viewer** tab.

The **2D** viewer will also open when you review a dataset from the **Browser** component.



Figure 224: 2D tools

1. Select a patient from **Browser**, select the series to view.

The **Viewer** tab is enabled and opens to the **2D** tab.

2. Use any of the image tools to view the image differently (zoom, pan, invert, etc.) to manipulate your image.
3. Click the **Reset** button to reset images back to the original setting(s).  
You cannot undo this action.

## Viewing images in MPR

**Multi-Planar Reformation (MPR)** allows you to view the volume of images in **Transverse (Axial)**, **Coronal**, and **Sagittal** planes.

**Viewer layout** is 2 x 2 as seen below.

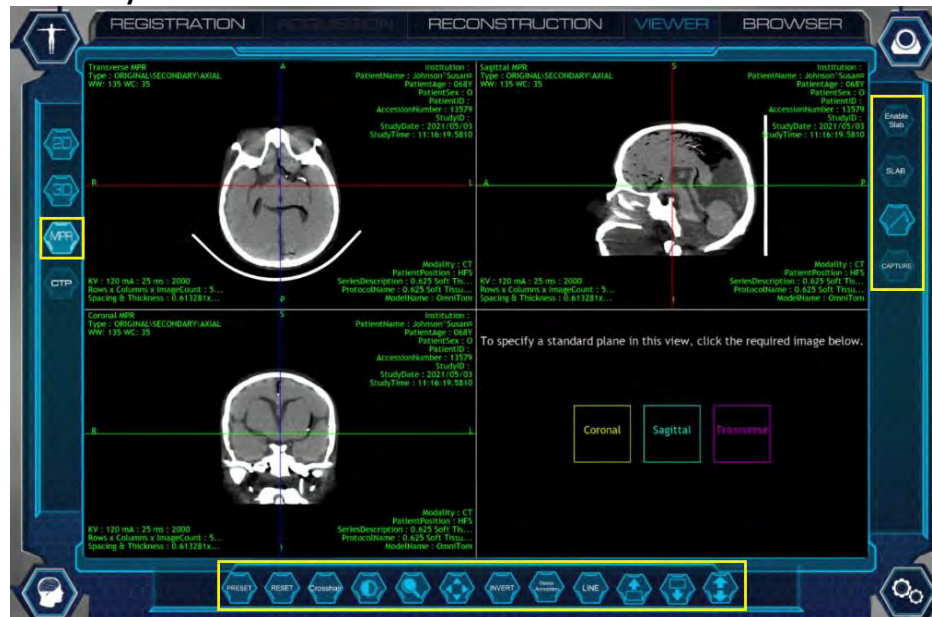

Figure 225: MPR tools

1. Select a patient from **Browser**, select the series to view.
2. The series will autoload to the **Viewer**.
3. Select the **MPR Icon**.
4. Use any of the image tools to view the image differently (zoom, pan, invert, etc.) to manipulate your image.
5. The tilt or rotation tool can be used to modify the rotation of images.
6. Adjust the image angle by moving the circle clockwise or counterclockwise.
7. Click the **Reset** button to reset images back to the original setting(s).  
You cannot undo this action.

## Understanding and using slab

**Multi-Planar Reformation (MPR)** allows images to be created from the original **Axial** plane into **Coronal**, **Sagittal**, or **Transverse** planes. **MPR** is fast, uses all the attenuation values in the dataset, and can easily be performed at the Tablet. **MPR**, however, provides only a **two-dimensional (2D)** display of the image data.

Sliding slabs are an additional technique used to create and save a series of MPR images in any plane. Through the reformation process, axial images are stacked creating a volume that can be dissected in different planes. The thickness and spacing of each dissection or slab can be varied to meet the needs of the viewer.

The reformations can be displayed in a minimum, maximum, or average projection.

**Note:** **MPRs** should be created from 0.625 or 1.25mm slices.

## Creating the slab

1. Select a patient from **Browser**.
2. Select the desired series from the **Series Table**.
3. The selected series will autoload to the **Viewer**.
4. Select the **MPR Icon**.
5. Click the Sagittal, Coronal, or Transverse plane to create your slab.



Figure 226: Coronal, sagittal, and transverse plane options

6. Select **Enable Slab**.
7. Set the **Cyan** lines to determine the beginning and end of the slab.

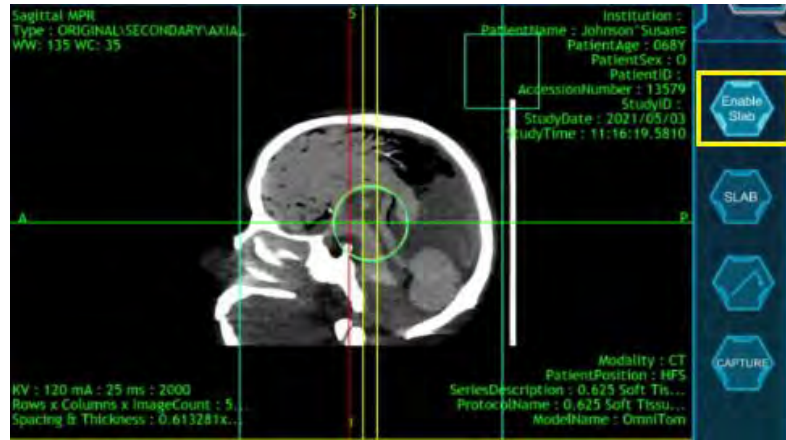

Figure 227: Set the cyan lines

8. Select Slab to set the thickness of the slices throughout the slab. Thickness and spacing can be entered manually or by selecting a pre-defined MPR Preset.



Figure 228: Slab option

9. Press the **Slab Rendering Options** dropdown to select the appropriate option.

The following options are available in MPR Mode:

Table 52: MPR Options

<b>Slab Thickness</b>	The value that defines the thickness of the slab.
<b>Slab Spacing</b>	The value that defines the space between the start of one slab and the next.
<b>Slab Rendering Options</b>	Where you define what pixel values are displayed in each slab: options include Average, Maximum Intensity, and Minimum Intensity.
<b>Maximum Intensity</b>	The highest pixel values for all slices within the slab displayed.
<b>Minimum Intensity</b>	The lowest pixel values for all slices within the slab is displayed.

<b>Average</b>	The pixel values of all slices within the slab are added up and the average value for each pixel is displayed.
<b>Yellow lines</b>	Changes made to the slab thickness using the markers are reflected in the value defined in the control panel.
<b>Cyan lines</b>	Define the slab <b>FOV</b> and dictate the range of a new series when generated. The cyan lines are adjustable by pressing and dragging on the lines themselves; both lines (at one time) are moved by clicking and dragging the central circle marker.
<b>Crosshairs – Red, Green, Blue</b>	Define the cross sections of the anatomy being viewed.
<b>Capture</b>	Generates a new series with the name given in the <b>Series Description</b> field, based on the selected <b>MPR</b> view pane.

10. Select the Tilt Tool to correct any rotation on the image

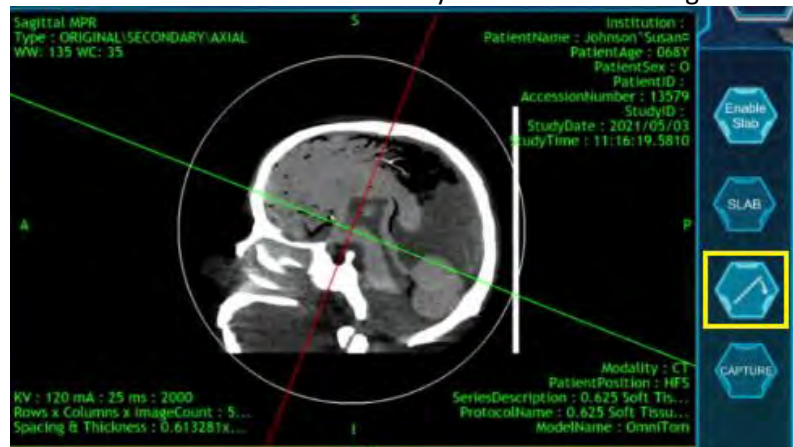

Figure 229: Using the tilt tool

11. Move the white circle on the image by placing your finger directly on the circle or just outside of it.

**Note:** The circle does not represent the Field of View.

12. The slab can be previewed in the bottom right viewport.

13. When you are ready to save, press the **Capture** button.

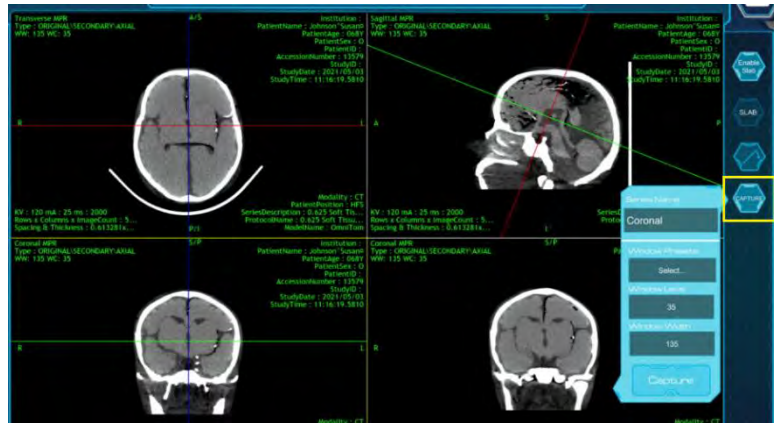

Figure 230: Capture dialog box

14. The **Capture** dialog box opens. Adjust **Window Width** and **Level** with the text box or use the windowing **Presets**.
15. Enter the series name and press **Apply** to keep settings.
16. To save the series press the **Capture** button. The new **MPR** image(s) appear in the **Browser** under the patient with the description (identifier) entered in the **Series Name** field.
17. To create additional MPRs, select the Reset button in MPR mode, select the MPR view you want to create and perform the steps above to create the new view.

## Viewing images in 3D

In **3D** viewing, a **3-Dimensional** image is created by stacking all the images of a scan on top of one another to create a 3-D volume.

**Note:** Any modifications you make are not saved to the image.



Figure 231: 3D viewing

1. Select a patient from Browser and select the series to view.
2. To open the image, select the series and it will autoloading to the **Viewer**.
3. Click the **3D** tab to dropdown the panel.
4. Use any of the image tools to view the image differently (zoom, pan, invert, rotate, etc.) to manipulate your image.
5. To rotate the image up to 360°, click (**Rotate**) and move the image by pressing on the screen to the rotation of choice. Use any of the image tools to view the image differently (zoom, pan, invert, rotate, etc.) to manipulate your image.

## Viewing images in CTP

**Computed Tomography Perfusion (CTP)** is viewer software that enables your system to view dynamic scans to evaluate cerebral perfusion in the brain. The **CTP** viewer functionality is only possible if the optional perfusion package is set up and enabled on your system. A scan must have been performed with perfusion protocols.



1. Perform a Dynamic-CTP scan as outlined in Chapter 9 Patient Scanning.
2. Go to the Browser screen to load the Dynamic-CTP scan into Viewer.







Figure 232: Dynamic CTP viewer

3. Select **CTP** button on the left.
4. Select the **Scroll**, **Window Level**, **Zoom**, or **Move** viewer buttons at the bottom to set the viewer mode and display of the scanned image. Select and drag in the viewer to adjust the selected mode.
5. Select and hold the **Scroll Forward** or **Scroll Backward** buttons to scroll through the viewer images.
6. The CTP Viewer Tools are reviewed in the table below.

Table 53: CTP Viewer Tools

CTP Viewer	Description
	Select to place the arterial and venous ROIs on the image.
	Hides the arterial ROI.
	Hides the venous ROI.

	Select to calculate the CT Perfusion maps.
	Blends the original scan with the perfusion maps.
	Reset
	Captures a screenshot of the maps.
	Shows a graph of the arterial and venous blood flow.

7. Select **Perfusion ROI** button in the upper right.

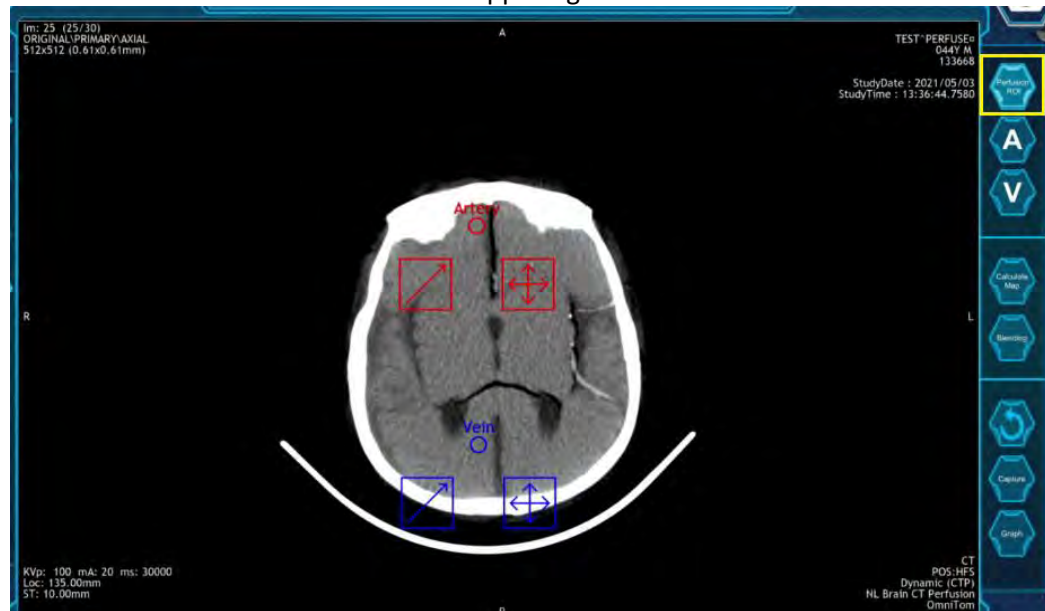

Figure 233: Arterial and venous ROI's

8. Tap the scan image in the viewer to place the **arterial ROI**.
9. Tap the scan image in the viewer to place the **venous ROI**.
10. Select and drag the scale box on either ROI to adjust the size of the ROI.
11. Select and drag the move box on either ROI to adjust the position of the ROI.

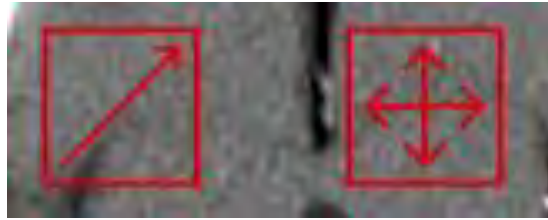

Figure 234: Adjust position of ROI

12. Select the **A (Arterial)** and **V (Venous)** buttons to toggle the ROI's on and off or hide the respective ROI's if they overlap.
13. Select the **Calculate Map** button to calculate the perfusion map. After calculation completes a 4-port window displays 3 ports with the calculated maps and the original scan image.

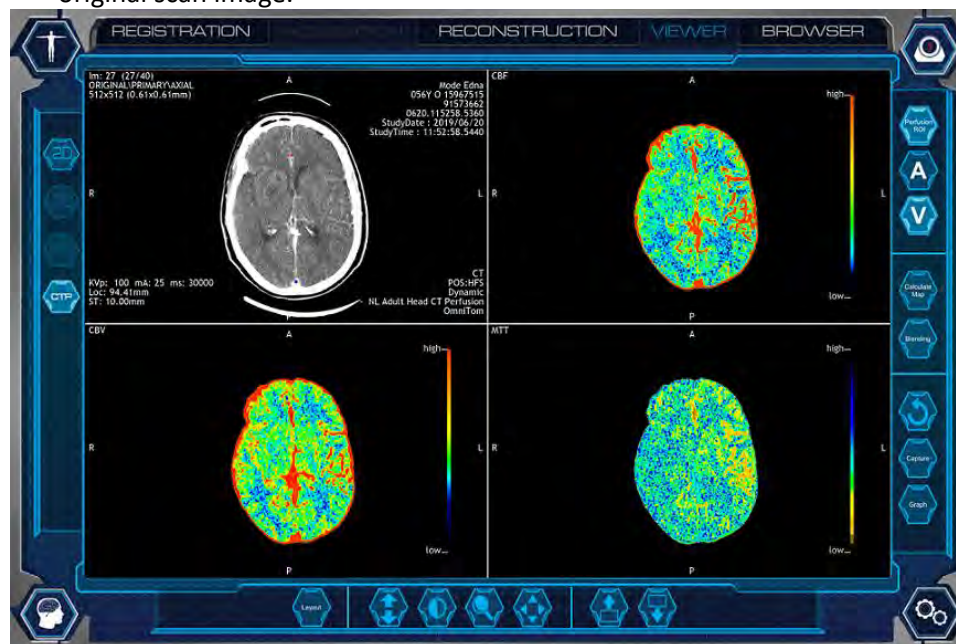

Figure 235: Perfusion maps

14. Select the **Blending** button to activate blending mode. The mode displays the scan image overlaid on the calculated maps. Select the Window Level button and select and drag on the scan image to adjust the amount of blend.
15. Select the **Reset** button to set the viewer back to the uncalculated, starting state.
16. Select the **Capture** button to save a copy of the current scan image and perfusion maps to the browser.
17. Select the **Graph** button to display the Arterial Venous Flow values mapped over time.
18. Select the **Layout** button to view various layouts of the scan image and perfusion maps.

## Chapter 12 Reconstruction

### Reconstruction overview

The system stores multiple patient series of raw data to allow post reconstruction of images. **Reconstruction** allows reconstructing of the acquired data using different algorithms, slice thicknesses, or use of image enhancement algorithms, such as **Metal Artifact Reduction** and **Noise Reduction**.

**Reconstruction Groups** can be added to the protocol, as seen in Chapter 5 System Settings, or performed manually.

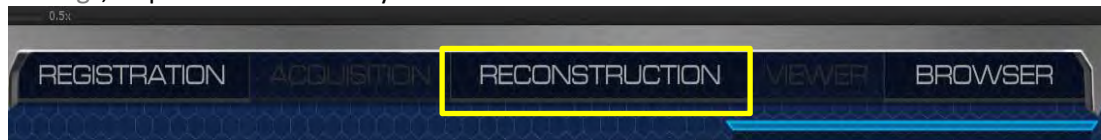

Figure 236: Active reconstruction tab

The tools available for **Reconstruction** are identified in the table below.

Table 54: Reconstruction tools









Image tools	Tool name	Action
	<b>Load All Images</b>	Loads image series into the viewer.
	<b>Reset</b>	Reverts all images back to their original parameters.
	<b>Windowing</b>	Adjusts the width and level of selected image.
	<b>Zoom</b>	Magnifies the image.

Image tools	Tool name	Action
	<b>FOV</b>	Adjusts the <b>Field of View (FOV)</b> prior to reconstruction. *This icon will remain inactive until the user selects "Load All Images".
	<b>Delete FOV</b>	Deletes the <b>Field of View (FOV)</b> *This icon will remain inactive until the user selects "Load All Images".
	<b>Scroll</b>	Press to activate – allowing you to scroll up or down through the images by swiping up or down on the image.
	<b>Page Down</b>	Press or hold to page down through the image set.
	<b>Page Up</b>	Press or hold to page up through the image set.

## Performing a reconstruction

The following figure identifies parts of **Reconstruction**: Settings Table and Viewing Pane.

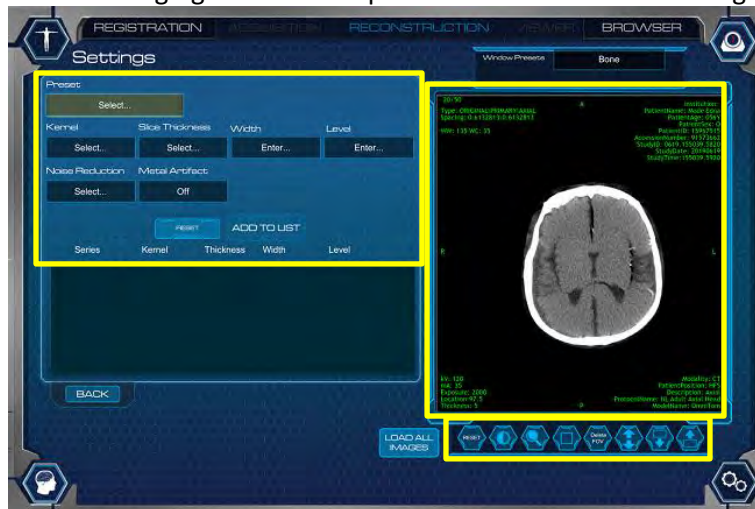

Figure 237: Reconstruction areas

1. Select a study in the **Studies** table.  
When you select a study, all of the scanned series for that study appear in the series table.
2. Select the series in the **series** table.

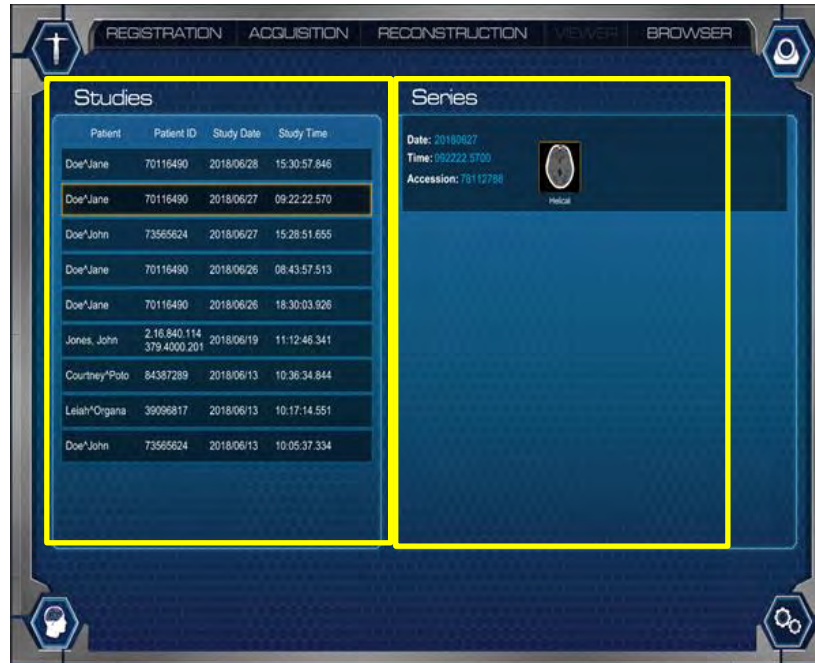

Figure 238: Reconstruction studies and series tables

- The settings table containing the available reconstruction parameter options will illuminate.
- To view the study in the viewing pane, select **Load All Images** (see the reconstruction viewing pane in Figure 239 below).



Figure 239: Reconstruction viewing pane

- Select the **Recon Preset**, **Recon Group**, or **Kernel** dropdown to select a reconstruction algorithm (Kernel) or a user defined set of reconstruction parameters (Recon Preset or Recon Group).

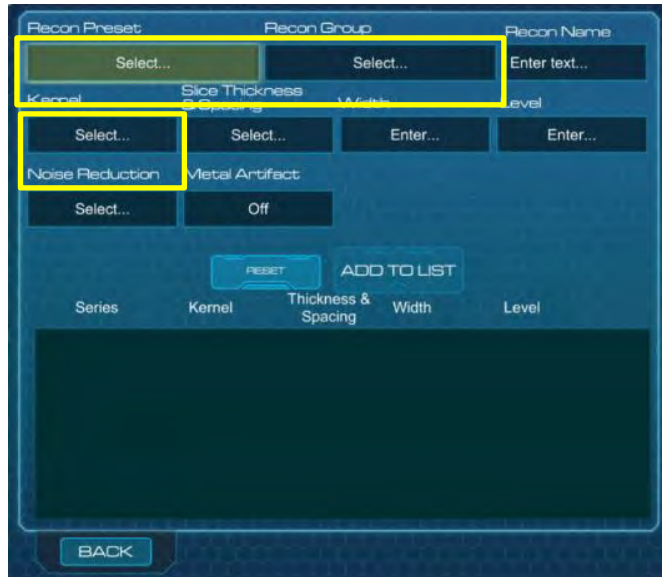

Figure 240: Post reconstruction's parameters

The kernel is modified by using one of the following algorithms:

- Low Noise QA**
- Soft Tissue**
- Posterior Fossa**
- Sharp**
- Bone**
- High Res QA**

**Note:** Low Noise QA and High-Res QA kernels should not be used for clinical imaging.

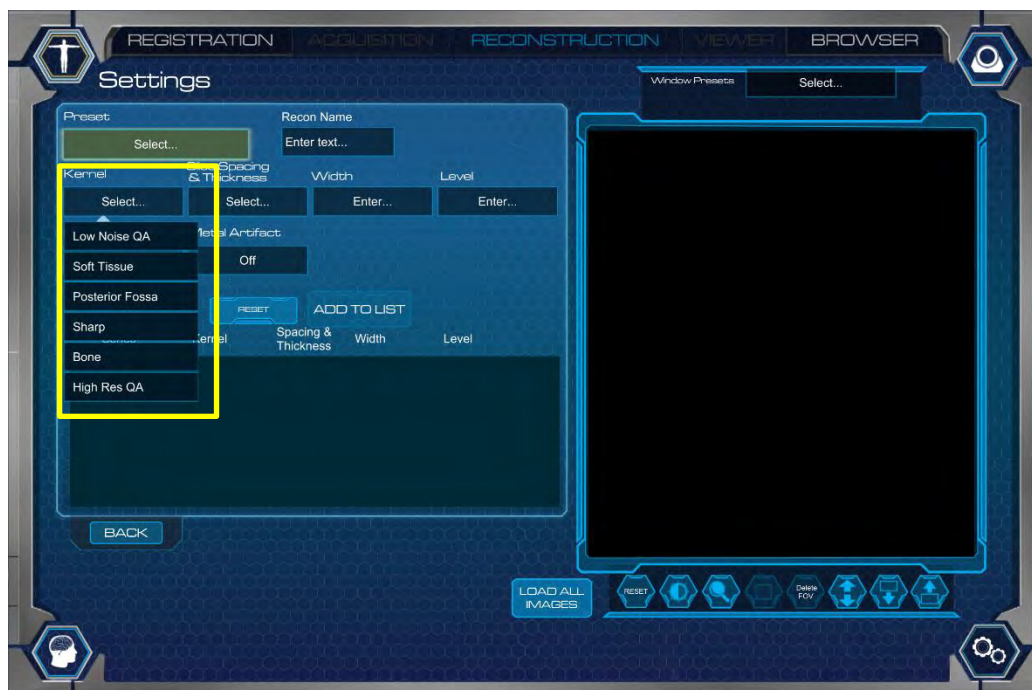

Figure 241: Select modifications

1. Select the **Slice Thickness/Spacing** dropdown to select a value.



Figure 242: Reconstruction parameters slice thickness/spacing dropdown

The slice thickness and spacing are adjusted depending on if you reconstruct an Axial or Helical scan.

2. If desired, select the **Noise Reduction** dropdown to add Noise Reduction to reconstruction. Noise Reduction options include **Low, Medium, or High**.
  - **Noise Reduction** is a semi-iterative reconstruction technique designed to decrease the noise level in reconstructed images.
  - **Noise Reduction** is recommended for pediatric scanning and for scanning large patients when constructing thin slices. Currently, the option is only provided for post reconstruction.
3. If desired, select the **Metal Artifact Reduction** dropdown to add Metal Artifact Reduction to reconstruction.
  - **Metal Artifact Reduction** is an iterative reconstruction designed to minimize streak artifact and signal loss due to metal in the reconstructed images.
  - **Metal Artifact Reduction** is currently available only to axial scans during post reconstruction.
4. Once parameter values are selected, press **Add to List**. You may add up to five (5) different recon datasets to the list.
5. Press the **Begin** button to generate a new dataset(s).  
When you press the **Begin** button, the reconstructed image appears in the viewing pane.
6. When the reconstruction is complete, the image series appear in the **Browser**.

## Chapter 13 Accessories and Options

---

### Accessories and options overview

In this chapter, you will learn how to convert a bed, stretcher, or any type of adjustable surface into a scanning platform through the use of scan boards.

To request the catalog(s) to reference product descriptions/details and part numbers for the available accessories/options that are used with the respective scanner, see “Contact information” on page 22.

When using a fixed scanner, the table moves from one portion of anatomy to another while the gantry remains stationary. With the OmniTom Elite, an in-place scanning platform remains stationary while the gantry or scanner translates from one point to the other to cover the anatomy.

The universal transfer board is used for most beds or stretchers that are not compatible with the customer’s bed adapter. It is placed under the patient and secured to the bed or stretcher with straps.

---

**Note:** The Universal Transfer Board may not be applicable for all beds.

---

A bed adapter is used as a secure mount to hold a silhouette scan board, which supports the patient’s head. Different beds or scanning platforms require different adapters. NeuroLogica manufactures many different bed adapters to fit a wide variety of hospital beds, stretchers, and Operating Room (OR) tables. The majority of the bed and stretcher adapters are designed to hold a silhouette scan board.



**WARNING** NeuroLogica Corp. recommends that the weight of the patient being positioned on the scan board does not exceed the bed manufacturer’s safe, recommended, operating patient load. Realizing patient safety is of the utmost importance, it is recommended that safe judgment be exercised at all times when it comes to the clinical care of patients. There are a number of varying factors, such as the condition of the bed being used, unique patient anatomy, as well as the proper scan board and positioning of the patient, per NeuroLogica Corp.’s clinical training guidelines and product labeling. If any excessive wear or damage is noticed to any scan board, do not use it for a patient scan; contact a qualified service technician to assess, repair, and/or replace the device.

---

### Using bed adapters

Bed adapters are manufactured for specific bed models. Prior to installing the OmniTom Elite at a facility, a precise survey is conducted to ascertain the type of bed used the most with the OmniTom Elite.

Adapters are classified as follows:

- Adapters that do not have posts and fit onto the frame of the bed by attaching to existing posts (below, left).
- Adapters that do have posts and fit onto the frame by inserting the posts into an existing hole in the frame (below, right).
- Adapters for OR tables, used in surgical cases.
- Adapters for a neonatal scan platform for children.

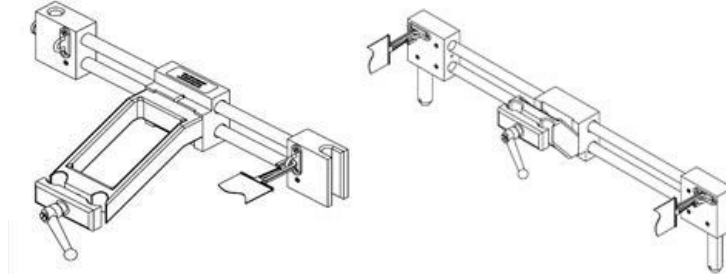

Figure 243: Bed adapter without posts (left) and bed adapter with posts (right)

## Using bed adapter safety straps

The bed adapter comes with two straps that attach to the rings on the adapter and can be used to secure the patient to the silhouette scan board.



Figure 244: Safety straps

1. Identify the rings on the bed adapter as highlighted on the Hill-Rom and Sytrker In Touch adapters below.

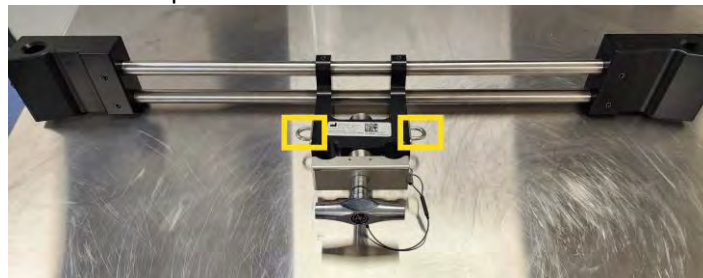

Figure 245: Hill Rom bed adapter

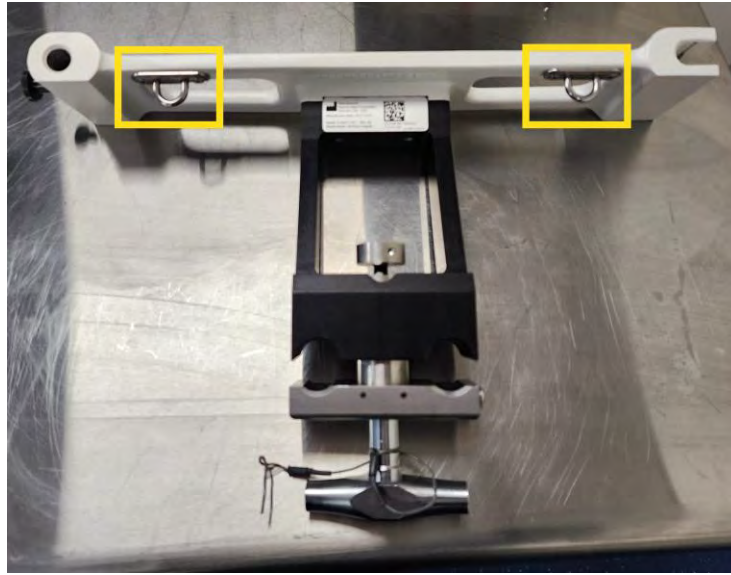

Figure 246: Stryker In Touch bed adapter

2. Connect the hooks on the straps to the rings on the bed adapter as seen below.



Figure 247: Straps attached to bed adapter

3. Attach the silhouette scan board to the bed adapter.

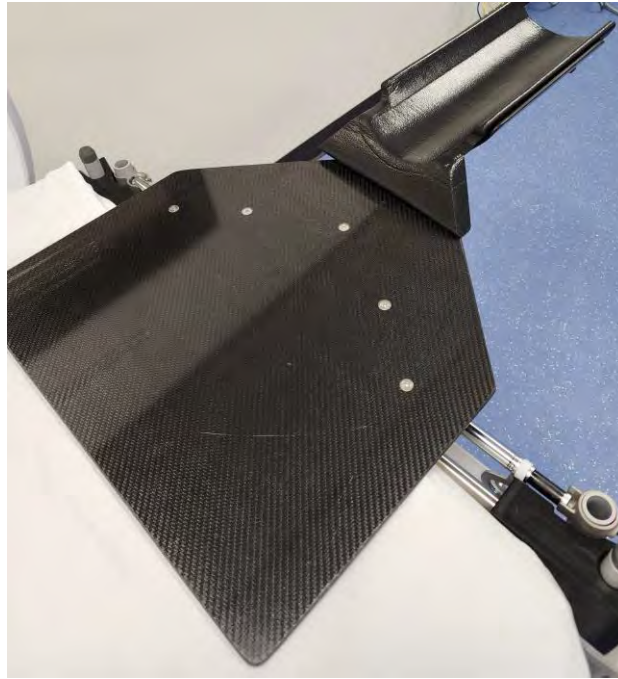

Figure 248: Silhouette scan board attached to bed adapter

4. Position the patient on the Silhouette scan board, and position the straps across the patients shoulders and upper chest to provide support and immobilization.

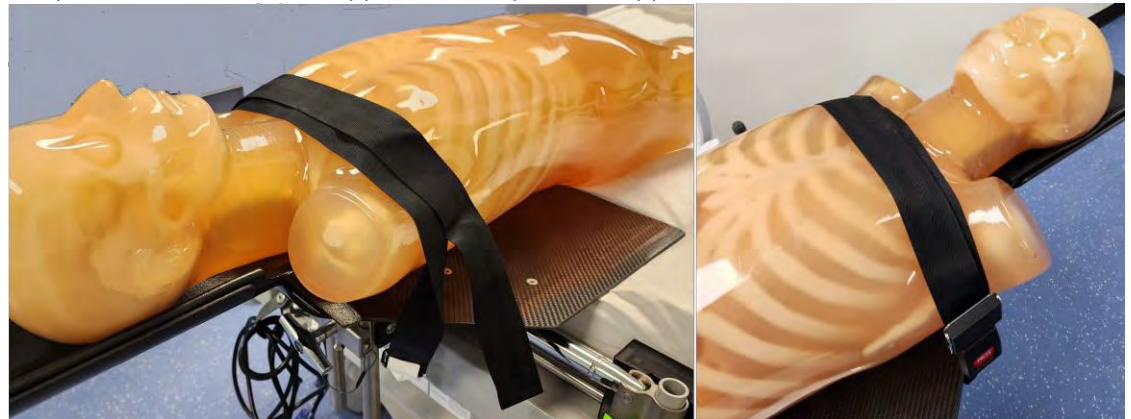

Figure 249: Patient properly immobilized on scan board

### Attaching bed adapter with or without posts

1. Check the bed adapter label and bed model to make sure the adapter is designed to fit the bed.
2. Remove the headboard from the bed.
3. Insert the bed adapter **without** posts onto the posts on the bed frame.



Figure 250: Bed adapter T-square handle

4. Make sure the adapter is flush against the bed frame.
5. Secure the adapter to the posts by adjusting the setscrew (see the yellow arrow in Figure 251)



Figure 251: Bed adapter without posts insertion (setscrew showing under arrow)

6. Attach the silhouette scan board to the bed adapter by inserting the scan board into the adapter block.



Figure 252: Bed adapter without posts shown being inserted into scan board

**Note:** Ensure that the bed's IV pole does not obstruct or interfere with the Silhouette scan board.  
Ensure T-square handle is properly tightened: listen for two clicks.

7. Press down on the silhouette scan board while tightening the T-square handle until two (2) clicks are heard.

8. Add the cushion to the head holder for the patient's comfort.



Figure 253: Silhouette with cushion shown on head holder

9. The headboard is now ready to receive the patient.

### Using the removable T-square handle with the bed adapter

**Note:** If the desired scan starting point is limited by the handle touching the front cover of the scanner, the handle can be temporarily removed once the scan board is in place without disturbing its position.

1. Confirm that the scan board is set to the desired height and the T-Square handle is secured as outlined above and T-Square handle is tightened until you hear two clicks.
2. Pull the knob below the handle down, approximately 1/8 inch and while holding it down slide the handle straight out from the scan board clamps as shown below.

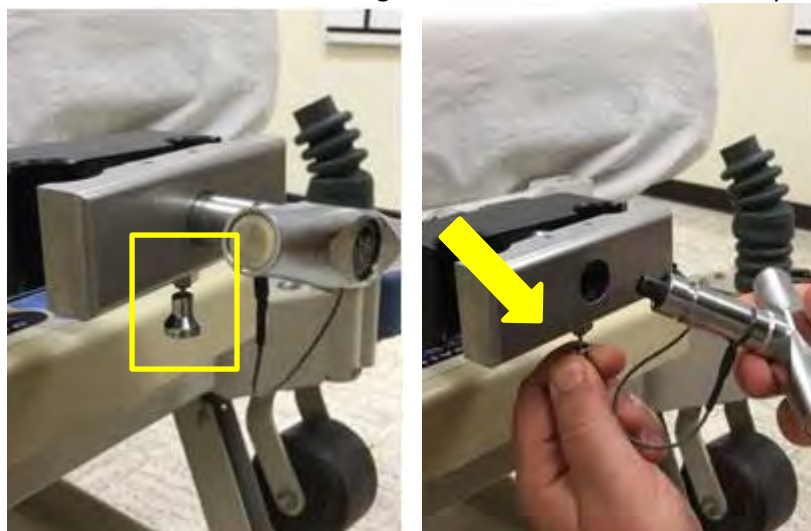

Figure 254: Steps showing removing T-square handle

**Note:** Put the handle somewhere safe where it will not interfere with the scan or just let it hang down from the clamp.

3. To reattach the T-Square Handle, first ensure the wire rope is not wrapped around anything. Pull the locking knob below the handle location down and slide the T-Square Handle back into the clamp.
4. Keep hold of the handle and release the locking knob. You may need to rotate the handle a small amount, less than 1/4 turn, and you will feel the handle slide in further around 1/4", and the locking knob will snap into place as shown in the figures below.



Figure 255: Steps showing reattaching T-square handle

5. Confirm that the line on the handle shows that it is installed to the correct depth.



Figure 256: Correct install depth

---

## Transfer boards for adult, pediatric, and neonate patients

Scan boards are customized for adult, pediatric, and neonate patients. Universal transfer boards and silhouette scan boards are used for adults; pediatric and neonate scan boards, and platforms are designed for smaller patients.

Table 55: Scan boards and their weight-bearing restrictions

Scan board/platform	Weight
Neonate scan platform	7.5kg / 17lbs
Pediatric scan platform	24.9kg / 55lbs
Silhouette scan board	Weight limit of board is equal to the weight limit of the patient bed; weight limit on portion supporting patient head is 7.5kg / 17lbs
Universal transfer board	Weight limit of board is equal to the weight limit of the patient bed; weight limit on portion supporting patient head is 7.5kg / 17lbs

See also “Parts that potentially come into contact with the patient” on page 64.



**WARNING** The weight limit for the superior portion of all scan boards (head) cannot exceed 7.5kg or 17lbs.

## Using the universal transfer board and silhouette scan board

The universal transfer board and silhouette scan board are both carbon-fiber, radiolucent boards that are designed to work with any ICU bed or stretcher. The carbon-fiber board comes with a 0.5 in. (thick) headboard and 2 in. x 5 ft. straps to strap the board to the ICU bed or stretcher.

You can use the universal transfer board or silhouette scan board on most beds, tables, or stretchers. Because you can attach the universal transfer board to almost any type of surface, it is used anywhere throughout the hospital including the ICU, OR, and ER. The universal transfer board is placed on the mattress and secured with a strap or placed directly on a surgical table under the cushions. The patient lies on the board with the patient’s head in the head holder. The OmniTom Elite is moved into position and the scan is performed.

The universal transfer board is always used with mattress stiffeners.

The mattress stiffeners provide a hard surface at the head of the bed to prevent the mattress from sagging when a scan is performed. There are usually four mattress stiffeners stored with the OmniTom Elite for easy transport.

**Note:** The universal transfer board and pediatric scan board are an optional accessory that does not come with the system.

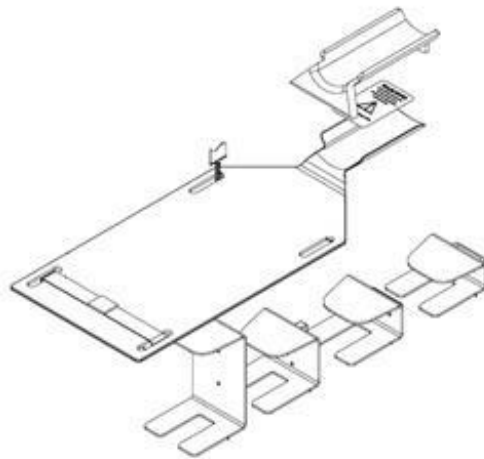

Figure 257: Universal transfer board and stiffeners

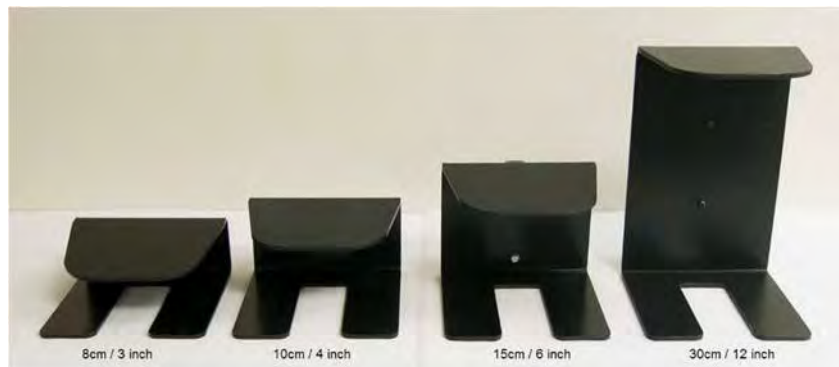

Figure 258: Four types of mattress stiffeners

**Note:** Tipping of the board is a major concern. The universal transfer board **MUST** be securely fastened to the surface prior to placing the patient on the board.

1. Obey all warning labels when using the scan board.
2. Select the appropriate mattress stiffener for the mattress size and insert.



Figure 259: Mattress stiffener in place

3. The universal transfer board requires mattress stiffeners that provide a hard surface at the head of the bed to prevent the mattress from sagging with the weight of the patient when a scan is performed.
4. With the proper mattress stiffener properly inserted, apply the universal transfer board on top.
5. Position the board in accordance with the yellow, safety-warning stickers to avoid a tipping hazard. Do not extend the board beyond the mattress for proper placement.



Figure 260: Universal transfer board properly positioned on the bed on a mattress stiffener

6. When the board is properly positioned on the bed, secure it by using the safety strap.
7. The safety strap must be attached to the board, passed completely under the bed, and secured on the other side.



Figure 261: Universal transfer board with safety strap installed

8. When the universal transfer board is securely fastened to the bed, transfer the patient to the board, and secure the upper strap to the patient and the scan board.
9. When the patient is positioned and securely strapped in, position the scanner over the patient.
10. Initiate the scan.

## Using the pediatric scan platform

**Note:** The Pediatric scan platform is used for larger children that cannot be supported by the infant/neonatal scan platform.



Figure 262: Pediatric scan platform



**WARNING** The **maximum** weight limit for the Pediatric Scan Platform is 24.9kg / 55lbs.



**WARNING** The pediatric scan platform is not a transportation device and should never be used to move a child from one location to another.



**CAUTION** Always secure the child to the scan platform with the safety strap as described below to prevent motion and falls.



**WARNING** **Never** leave the child unattended on the platform!



**CAUTION** Read and observe all warning labels.



**CAUTION** **Never** remove the scan board from the platform in order to use it separately.

**Note:** The pediatric scan platform is used to scan on adolescents too large to be scanned on the neonatal scan platform, but too small to be scanned on their regular hospital bed.

1. Place the child on the scan platform and secure with the safety strap.



Figure 263: Child placed on pediatric platform with safety strap (two views)

2. Position the scanner over the platform to ensure the patient is centered using the laser light as a guide.

3. After the scanner and patient are properly positioned, lock the platform in place by stepping down on the brake lever. **Red** to lock platform and **green** to unlock platform.



Figure 264: Platform brake

## Using the infant and neonate scanning platform

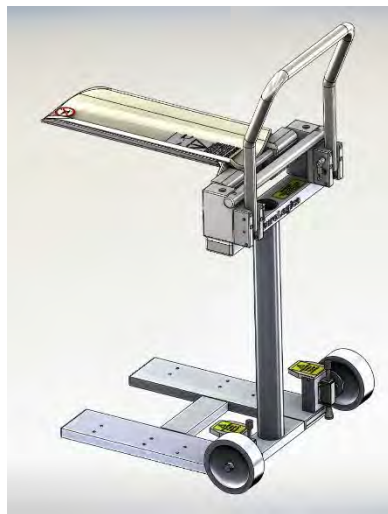

Figure 265: Infant and neonatal scan platform



**WARNING** The **maximum** weight limit for the neonatal scan platform is 7.5kg / 17lbs.



**WARNING** The neonatal scan platform **is not** a transportation device and should **never** be used to move a child from one location to another.



**WARNING** Always secure the child to the scan platform with the pediatric strap, as described in the following procedure, to prevent the child's motion and falls.



**WARNING** **Never** leave the child unattended on the platform!



**CAUTION** Read and observe all warning labels.

## Positioning using the infant and neonate scanning platform

1. Place the child on the scan platform and secure with the safety strap.



Figure 266: Pediatric strap

2. Drape the strap over the patient and secure one side around the patient with Velcro, then continue with other side.



Figure 267: Applying pediatric strap onto the platform (three views)

The neonate or infant patient can be positioned on the platform head-first for head scans, and feet-first or head-first for body scans.



Figure 268: Proper position of neonate/infant for head scans (left) and body scans (right)

3. The patient is now ready to be placed in the scanner.

**Note:** The platform remains stationary during the scan while the scanner moves during the scan.

4. Position the scanner over the platform to ensure the patient is centered using the laser light as a guide.
5. After the scanner and patient are properly positioned, lock the platform in place by stepping down on the plungers located on both sides.

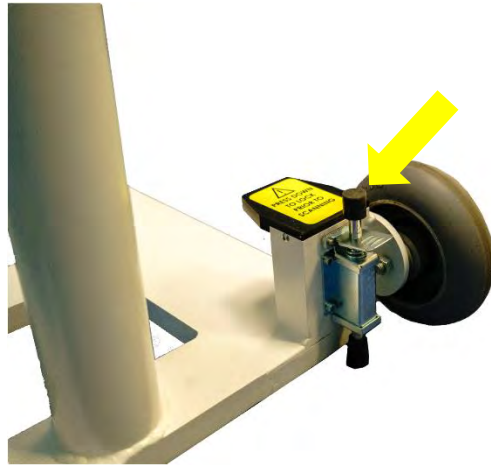

Figure 269: Neonate platform foot brake location

## Adjusting the infant and neonate platform handle

The Infant and Neonate Platform Handle is used for transporting and moving the imaging platform. The handle is adjustable and may be moved to accommodate for more space or user preference.



**WARNING** The neonatal scan platform *is not* a transportation device and should *never* be used to move a child from one location to another.

1. To adjust the handle, remove the two locking pins located on the insides of the handle by pressing down on the pin buttons and pulling back (see yellow boxes below).

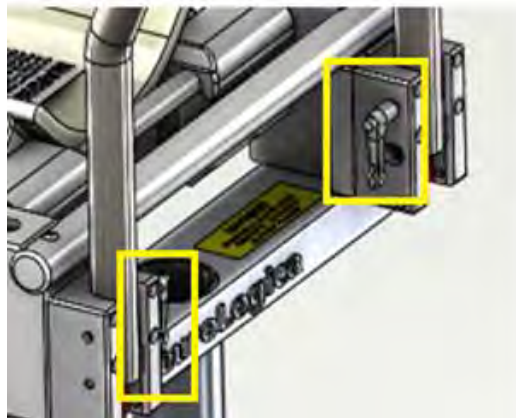

Figure 270: Locking pins for the handle

2. Position the platform handle in one of the three set locations (see figure below).



Figure 271: Three positions for the platform handle

3. Once adjusted to the desired position, secure the handle in place by inserting both of the locking pins into the slots. When pins are at proper depth and correctly seated, they will lock into place.



**WARNING** Ensure both pins are locked in a secure position prior to moving!

## Chapter 14 Using the OmniTom Elite in the Operating Room

The three methods used to convert the operating table into a scanning platform are as follows:

- An OR table adapter with the silhouette scan board
- Universal transfer board
- Doro® OmniTom Elite intra-operative cranial stabilization system

Each of the above-mentioned devices are covered in the following sections. It is important to note that all these devices are used pre, post, and intra-operatively.

---

### Using the operating room table adapter

The Operating Room (OR) table adapter functions in the same way as a bed adapter.

1. Attach the OR table and then the silhouette scan board to the adapter.

The OR table adapter has two posts that fit into the adapter supplied by either the OR bed manufacturer or by Mayfield.

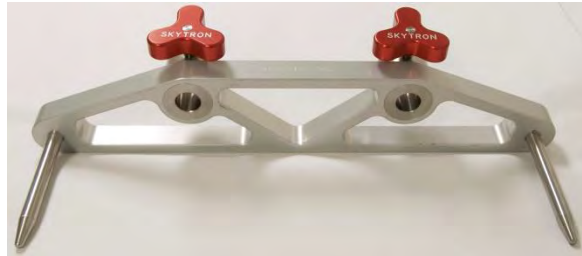

Figure 272: OR table adapter

2. Adjust the OR table adapter to the openings in the mount and attach it to the mount.



Figure 273: OR table adapter attached to mount

3. Attach the silhouette scan board to the OR table adapter.
4. Add the padding to the head holder and slide the patient onto the board.  
You can perform this step at scan time or before the start of surgery. If you perform it prior to surgery, the surgeon may choose to perform the surgery on the head holder.
5. Drive the scanner into place to start the study.

---

## Using the universal transfer board in the OR

The universal transfer board is a carbon-fiber, radiolucent board that is designed to work with most ICU beds or gurneys. The carbon-fiber board comes with a 0.5 in. (thick) headboard and 2 in. x 5 ft. straps to strap the board to the ICU bed or gurney. It also comes with 3 in., 4 in., 6 in., and 12 in. bed stiffeners.

In addition to using the OR adapter and silhouette board in the OR, the universal transfer board is often used in the OR. The universal transfer board is secured to the surgical table by placing the board under the table cushions (if used) and securing the safety strap to the table by passing the strap under it and securing it on the other side. The board is secured to the table prior to the patient's arrival. The patient is then placed on the table with the patient's head in the head holder. The surgery is performed with the patient on the universal transfer board. When a scan is needed, the OmniTom Elite is driven into place over the patient's head and the scan is performed. The universal transfer board is used for almost any non-invasive surgical procedure.

## Appendix A Glossary

### A

Algorithm	Mathematical filter applied to raw data during CT image reconstruction to remove blurring artifact inherent to back-projection. Also referred to as a kernel.
Annotation	User comments or text added to an image.
Anterior	Front of the patient's body
Application Entity (AE)	An end point of a DICOM information exchange, including the DICOM network or media interface software; that is, the software that sends or receives DICOM information objects or messages. A single device can have multiple AEs.
Attenuation	The reduction in intensity of a radiation beam as it passes through a substance.
Automatic Exposure Control (AEC)	Software used to adjust or modulate the mA throughout an acquisition to reduce patient radiation dose to a minimum.
Axial scan mode	Data acquisition while the scanner remains stationary. The scanner position may be incremented between exposures to collect data over a longer Z axis range.

### B

Beam hardening	The phenomenon whereby low energy photons are absorbed as the x-ray beam passes through an object, resulting in an increase in the average photon energy of the beam.
Bolus tracking	Monitors flow of contrast media in vessel and triggers scan at optimal timing. This is a scanner feature to automatically initiate a prescribed Helical scan when a threshold level of contrast enhancement is reached at a specified region of interest.

### C

Center X, Center Y	Reconstruction coordinates of an image.
Collimation	Restricts x-ray to only the selected anatomy, minimizing dose to patient and reducing scatter.
Computed Tomography Angiography (CTA)	A test that uses x-rays to provide detailed pictures of the heart and the blood vessels that go to the heart, lung, brain, kidneys, head, neck, legs, and arms. A CT

	angiogram can show narrowed or blocked areas of a blood vessel.
Computed Tomography Dose Index (CTDI)	An approximate measure of the radiation dose received in a single CT section or slice.
Computed Tomography Dose Index Volume (CTDI <sub>vol</sub> )	Represents the dose for a specific scan protocol, which takes into account gaps and overlaps between the radiation-dose profiles from consecutive rotations of the x-ray source. The CT dose index volume is noted as CTDI <sub>vol</sub> . The CTDI <sub>vol</sub> is calculated differently for both the Axial and the Helical mode: <ol style="list-style-type: none"> <li>1. For Axial scan mode: <math>CTDI_{vol} = [(N \times T)/I] \times CTDI_w</math></li> <li>2. For Helical scan mode: <math>CTDI_{vol} = 1/pitch \times CTDI_w</math></li> </ol>
Computed Tomography Dose Index (CTDI <sub>w</sub> ) weighted average	The measure of ionizing radiation exposure per slice of data acquisition. CTDI represents the integrated dose along the Z axis from one axial CT scan (one rotation of the x-ray tube). The CT Dose Index is noted as CTDI <sub>w</sub> .
Computed Tomography (CT) number	Relative value assigned to each pixel to quantify the attenuation occurring in each pixel in comparison with the attenuation of water. The calculated CT number for a given pixel is given in Hounsfield units (HU).
Computed Tomography Perfusion (CTP)	Evaluates cerebral perfusion or level of blood flow in the brain by monitoring the initial passing of iodinated contrast media through the vasculature of the brain.
Contrast media	Used to improve sensitivity and specificity of clinical diagnoses.
Contrast resolution	The ability of a CT system to detect an object with a small difference in linear attenuation coefficient from the surrounding tissue. Also referred to as low-contrast detectability or sensitivity.

## D

Digital Imaging Communication in Medicine (DICOM)	Digital Imaging and Communications in Medicine, or DICOM, is a standard that helps people doing work in the field of radiology. The DICOM standard is designed to promote communication and integration between a variety of radiology imaging systems and equipment used in filmless radiology.
Digital tilt	The ability to correct the image post acquisition and correct positional inaccuracies prior to sending to PACS.
Dose	Amount of ionizing radiation absorbed by patient per unit mass.
Dose Length Product (DLP)	The measurement of dose for an entire series of CT images. DLP is equal to the calculated dose per section

	multiplied by the length of a CT acquisition along the Z- axis.
Dynamic Host Control Protocol (DHCP)	A standardized network protocol used on Internet Protocol (IP) networks. The DHCP is controlled by a DHCP server that dynamically distributes network configuration parameters, such as IP addresses, for interfaces and services.
Dynamic scan mode	Data acquisition at multiple time points over the same anatomic location(s).

## E

Electromagnetic Compatibility (EMC)	The branch of electrical sciences that studies the unintentional generation, propagation, and reception of electromagnetic energy with reference to the unwanted effects (Electromagnetic interference (EMI)) that such energy may induce.
Electromagnetic Interference (EMI)	A disturbance generated by an external source that affects an electrical circuit by electromagnetic induction, electrostatic coupling, or conduction. The disturbance may degrade the performance of the circuit or even stop it from functioning.

## F

Field of View (FOV)	The diameter of the acquired images displayed across the image matrix.
---------------------	--

## H

Helical	A CT acquisition where the x-ray tube and scanner move continuously during scanning, yielding a data set in the form of a helix. Also referred to as spiral.
Hospital Information System/Radiology Information Systems (HIS/RIS)	A Radiology Information System (RIS) is the core system for the electronic management of imaging departments. The major functions of the RIS can include patient scheduling, resource management, examination performance tracking, examination interpretation, results distribution, and procedure billing. RIS complements Hospital information systems (HIS) and Picture Archiving and Communication System (PACS), and is critical to efficient workflow to radiology practices.
Hounsfield Unit (HU)	The unit of the CT number scale assigned to each pixel to quantify relative attenuation.

## I

Interscan delay time	Minimum amount of time that must transpire between end of one scan and initiation of next scan. Interscan delay times include idle time between scans to allow tube cooling.
Iterative Bone Correction (IBC)	A feature build into the reconstruction software, which performs a correction on every Axial image the scanner produces, including both primary series from a scan as well as secondary reconstruction images. Current IBC settings were chosen to provide optimal correction for standard medical imaging; however, the setting can be customized as needed.

## K

Kernel	A mathematical filter applied to raw data during CT image reconstruction to remove blurring artifact inherent to back-projection. Also referred to as an algorithm.
--------	---

## L

Liquid Crystal Display (LCD)	A form of visual display used in electronic devices in which a layer of a liquid crystal is sandwiched between two transparent electrodes. The application of an electric current to a small area of the layer alters the alignment of its molecules, which affects its reflectivity or its transmission of polarized light and makes it opaque. An LCD is used on the scanner and is a touch screen.
------------------------------	---

## M

mAs	Tube current-time product: The product of tube current and exposure time per rotation, expressed in units of milliampere seconds (mAs).
Matrix	Two dimensional grid numbers arranged in rows and columns.
Maximum Intensity Projection (MIP)	The multiplanar reformation technique that displays only the maximum pixel value along a ray traced through the object to the viewers assumed perspective in front of the viewing monitor.
Mean Transit Time (MTT)	A common measurement during CT perfusion studies of the brain. Refers to the average transit time, in seconds, needed for blood to pass through a given region of brain tissue.

milli amperage (mA)	Tube current: the number of electrons accelerated across an x-ray tube per unit time, expressed in units of milliamperage (mA).
Modality Performed Procedure Step (MPPS)	A mechanism for modalities to pass information about the imaging performed back to the HIS/RIS or PACS.
Modality Worklist Manager	Scheduled (but not yet scanned) patient list.
Motion artifact	Voluntary and involuntary patient motion during CT scan, appearing as a streak artifact on image; ghosting or blurring of image.
Multiplanar Reformatting (MPR)	The process of displaying CT images in a different orientation from the one used in the original reconstruction. Allows for reformation of images in planes that would otherwise be difficult or impossible to acquire with CT. Requires only image data. Raw data is not utilized.

## N

Noise	Random statistical variations in the signal. Can be quantum noise, electronic noise due to lost signal, or artifact noise. Manifests itself as overall graininess of the reconstructed image.
-------	---

## P

Partial volume artifact	Occurs when an object is only partly positioned within a voxel or is much smaller than the overall voxel volume. The object's attenuation is not accurately represented by the pixel value. Overlapping reconstructions further reduce partial volume artifacts.
Patient coordinates	References are as follows: X left to right. Y anterior to posterior. Z head to feet.
Browser, local database	Where the already-scanned patient list is stored.
Peak kiloVoltage (kVp)	The penetrating power of the photons coming from the x-ray tube.
Picture Archive and Communications Systems (PACS)	Stores medical information, including 2D images, and 3D medical images. All modern PACS setups will work with DICOM.
Pitch	In Helical mode, refers to the speed of the scanner movement over the table as the scanner rotates.
Pixel	A single, picture element of image matrix.
Post reconstruction	Prescribing the reconstruction parameters after scan acquisition.

Projection	View of anatomical cross-section from a particular vantage point.
Prone	Patient lying on stomach.
Protocol	Prescribes the acquisition and reconstruction parameters to be used for a scan.

## Q

Quality Assurance (QA)	Procedure of performing periodic specified tests or measurements to assure that a set quality level, as specified by system manufacturer, has not been compromised.
------------------------	---

## R

Radiation Safety Officer (RSO)	The person within an organization responsible for the safe use of radiation and radioactive materials as well as regulatory compliance.
Radio Frequency Interference (RFI)	Also called Electromagnetic Interference (EMI), is an unwanted disturbance that affects an electrical circuit due to electromagnetic radiation emitted from an external source.
Raw data	A transmission measurement obtained by the detectors used to mathematically reconstruct the CT image.
Reconstruction filter	Used to ensure accurate anatomical image reconstruction. Also allows for either spatial resolution or low-contrast-resolution enhancement.
Region Of Interest (ROI)	Provides a quantitative analysis of the Hounsfield values of a specific anatomic area. A graphic outline in the shape of a circle is placed over an area on the image. Software calculates the average CT number in HU within the ROI.
Resolution	A scan time, per slice, in Axial mode, only.
Retrospective reconstruction	Reconstruction performed after the initial prospective reconstruction. Multiple retrospective reconstructions of raw data are possible, with changes to display FOV, kernel, slice thickness, etc.

## S

Scan delay	The time between the initiation of contrast agent administration and CT data acquisition. The chosen scan delay determines the phase of contrast enhancement for a given CT acquisition.
Scan protocol	A list of scanner-load parameters used to perform an x-ray exposure.

Scan types	Axial, Helical, Dynamic, Reference, and Scout.
Scout	Digital survey radiograph acquired by the CT system for the purpose of prescribing the cross-sectional acquisition. Similar to a conventional radiograph, the scout is produced by translating the scanner over the patient without tube or detector rotation. Also referred to as topogram or scanogram.
Series	A set of images acquired in a scan.
Slice spacing (Spacing)	The distance between the center of one CT slice and the center of the next slice.
Slice thickness	The dimension of a constructed CT slice along the longitudinal direction of acquisition (Z axis).
Spatial resolution	The ability of a CT imaging system to display fine details, separately. Given in units of line pairs per centimeter (lp/cm).
Supine	Lying on back.

## T

Temporal resolution	The ability of a CT system to freeze motion and provide an image – free of blurring.
Test Bolus	Scan mode used to measure the contrast transit time using a small injection of contrast media.
Threshold	The CT number (Hounsfield Unit (HU)) where bolus tracking tool will trigger the system to begin the scan.
Time Attenuation Curve (TAC)	A graph of the contrast enhancement versus time. TAC is used to determine blood flow rate in seconds for contrast timing.
Time delay	Monitoring delay: Time from injection to the start of monitoring scans.
Transverse plane	Perpendicular to direction of Z axis.

## V

Volume Rendering (VR) image or object	A 3D modeling technique that utilizes the entire acquired dataset but adjusts the opacity of the voxels included in the 3D image according to their tissue characteristics.
Voxel	Abbreviation of volume element. Refers to the volume of tissue represented by a pixel in the matrix used to display the CT image.

## W

Window Level (WL)	The pixel value given in Hounsfield Units (HU) at the center of the window width. Window Level controls the brightness (density) of the CT image.
-------------------	---

Window Width (WW)	The range of pixel values assigned a shade of gray in the displayed CT image. Window Width controls the contrast of the CT image.
-------------------	---

## Appendix B Error Codes

Table 56: Error code list

Error-code number	Fault description	Explanation	Cause <sup>2</sup>	Resolution
0	NO_FAULT	Success. No error occurred	N/A	N/A
1	ACQUISITION_TERMINATED	Not an error.	Acquisition has terminated normally (or user hit Cancel)	N/A
2	XRAY_TEMPERATURE_FAULT	Temperature fault was detected at X-ray tube	X-ray Tube overheated	Allow time for X-ray Tube to cool down
3	XRAY_ARC_FAULT	An X-ray tube arc was detected	An arc occurred in X-ray Tube or the HV Generator	Contact Technical Support for service
4	XRAY_HIGH_MA_FAULT	Monoblock high mA condition detected	Beam current exceeds set value by more than 5% for 100 ms or more	Contact Technical Support for service
5	XRAY_LOW_MA_FAULT	Monoblock low mA condition detected	Beam current is less than 95% of set value for 100 ms or more	Contact Technical Support for service
6	XRAY_LOW_KV_FAULT	Monoblock low kV condition detected	X-ray Tube voltage is less than 95% of set value for 100 ms or more	Contact Technical Support for service

<sup>2</sup> There may be multiple causes that require a trained service technician to conduct an analysis and repair.

Error-code number	Fault description	Explanation	Cause <sup>2</sup>	Resolution
7	XRAY_HIGH_KV_FAULT	Monoblock high kV condition detected	X-ray Tube voltage exceeds set value by more than 5% for 100 ms or more	Contact Technical Support for service
8	XRAY_WATCHDOG_FAULT	Monoblock watchdog timeout condition detected	Watchdog Timer was not refreshed at a high enough rate	Contact Technical Support for service
9	XRAY_POWER_LIMIT_FAULT	[Placeholder for power limit fault]	N/A	N/A
10	XRAY_INTERLOCK_FAULT	Interlock was de-asserted to generator	E-Stop was activated	Deactivate E-Stop
11	XRAY_BELOW_THRESHOLD	Reference detector values are reading less than threshold value	Indicates X-rays have been turned off (due to errors 2-10 above)	Contact Technical Support for service
12	A subsystem failed to respond in a timely manner. Please retry the operation	The Operating Systems are not (Recon and Tablet) are not communicating properly	The Reconstruction computer timed out when trying to execute the command	Try the operation again or restart the scanner
13	Unable to Prepare a scan. Recon is disconnected	Scan failed to prepare	Reconstruction Server not responding	Restart the scanner
14	Please verify the bore is empty and restart the Daily Calibration.	Daily Calibration could not be performed because the scanner detected something in the bore.	An object was in the bore.	Check bore, remove object, and restart Daily Calibration.

Error-code number	Fault description	Explanation	Cause <sup>2</sup>	Resolution
15	CANNOT_WRITE_TRANSMIT_QUEUE	When Data Acquisition System (DAS) views are acquired to disk during a scan, they are sent to a "Transmit Queue" from which they are sent to Recon computer over socket interface (Ethernet). If write of view to Transmit Queue fails, this error is flagged.	Likely causes of failing this write is if downstream data path is not functioning correctly (Ethernet unplugged, scanner app not connected, etc.) during a scan, and transmit queue is full and won't allow any more writes.	Contact Technical Support for service
16	INCORRECT_ROTATE_SPEED	Indicates disk detected a rotation speed error.	Happens when a problem with tick fence, or has incorrect calibration parameters.	Contact Technical Support for service
17	POSITION_ERROR	Translate wheels did not move specified distance.	Could be caused by incorrect calibration parameters, a translate jam, an uneven floor	Contact Technical Support for service
18	VELOCITY_ERROR	Translate velocity not as expected during a helical scan.	Could be caused by incorrect calibration parameters, a translate jam, an uneven floor	Contact Technical Support for service
19	OFFSET_CAL_FAULT	Offset calibration (done typically at beginning of every scan) has failed.	Due to bad view data from Disk Computer Assembly (DCA).	Contact Technical Support for service

Error-code number	Fault description	Explanation	Cause <sup>2</sup>	Resolution
20	AIR_CAL_FAULT	Air calibration failed.	An object was in the bore	Remove obstacle and perform another air calibration
21	INVALID_PROTOCOL	[Placeholder for invalid protocol error]	N/A	N/A
22	INVALID_COMMAND	[Placeholder for invalid command error]	N/A	N/A
23	INVALID_COMMAND_SEQUENCE	An invalid command sequence was detected.	Can happen when Disk Computer Assembly (DCA) receives Start Acq command from Scanner Control app, but is not in a READY state.	Contact Technical Support for service
24	INVALID_PARAMETERS	[Placeholder for invalid parameter error]	N/A	N/A
25	XRAY_COMMUNICATION_ERROR	Disk has detected a problem with serial port connection to monoblock	HV Generator fault, Disk Control Assy (DCA) fault	Contact Technical Support for service
26	DCB_COMMUNICATION_ERROR	[Placeholder for DCB communication error]	N/A	N/A

Error-code number	Fault description	Explanation	Cause <sup>2</sup>	Resolution
27	SUBSYSTEM_COMMUNICATION_ERROR	[Placeholder for subsystem communication error]	N/A	N/A
28	RECON_ERROR	Requested protocol has been rejected by Reconstruction App.	Recon Computer error	Contact Technical Support for service
29	INSUFFICIENT_TUBE_CAPACITY	When preparing for a scan, this error is flagged if tube capacity is lower than anticipated threshold value for that scan.	X-ray Tube too hot to perform prescribed procedure	Tube needs time to cool down before scan can be run.
30	INSUFFICIENT_BATTERY_CAPACITY	When preparing for a scan, this error is flagged if battery capacity is lower than anticipated threshold value for that scan.	Battery was not recharged per instructions	Battery needs to be recharged to minimum level by connecting it to AC outlet before scan can be run.
31	ESTOP_INTERLOCK	ESTOP button has been activated	User depressed ESTOP button	After respective issue has been resolved accordingly, user can deactivate E-STOP
32	HVG Cathode Error	N/A	N/A	Contact Technical Support for Service
33	SAFETY_INTERLOCK	[Placeholder for safety interlock error]	N/A	N/A

Error-code number	Fault description	Explanation	Cause <sup>2</sup>	Resolution
34	DAS_DATA_ERROR	Disk Computer Assembly (DCA) has detected a Data Acquisition System (DAS) Data Error from DCB device.	Defective Converter Board Assembly	Contact Technical Support for service
35	DAS_CALIBRATION_ERROR	Tick calibration data is invalid	Disk Computer Assembly (DCA) has detected a Data Acquisition System (DAS) Data Error from Disk Control Board (DCB)	Contact Technical Support for service
36	HOME_TICK_ERROR	Disk has detected a Home Tick Error from DCB device (no "home" pulse detected).	Typically this is a dirty/dusty Tick Fence Assembly or defective Tick Board Assy.	Contact Technical Support for service
37	TICK_ERROR	Disk has detected a Tick Error from DCB device (incorrect number of ticks counted).	Typically this is a dirty/dusty Tick Fence Assembly or defective Tick Board Assy.	Contact Technical Support for service
38	ROTATE_CONTROLLER_ERROR	Rotate drive detected an error while performing homing operation	Base Computer Assy. Interface with rotate motor controller has a fault.	Contact Technical Support for service

Error-code number	Fault description	Explanation	Cause <sup>2</sup>	Resolution
39	AIR_CAL_WARNING	Result of air calibration was out of tolerance	When requesting a new scan, currently loaded air calibration tables were generated from a previously failed air cal. Requested scan will be allowed to continue, but images may have artifacts. A pop-up window to user is presented upon this condition.	Contact Technical Support for service
40	RECON_BUSY	[Placeholder for recon busy error]	N/A	N/A
41	INSUFFICIENT_DISK_SPACE	Not enough disk space to store information on the Recon Computer	Hard drive on Recon Computer does not have enough space for image data.	Contact Technical Support for service
42	Failed to process image. Exported image null? {true/false} imagePath null? {true/false}	N/A	N/A	Restart the scanner and try executing command again
43	Error in protocol validation. Please reboot the scanner and try again	N/A	N/A	Restart the scanner and try executing command again

Error-code number	Fault description	Explanation	Cause <sup>2</sup>	Resolution
44	One of the subsystems have disconnected. Please reboot the scanner	Recon Server not responding	N/A	Restart the scanner
45	Error retrieving original protocol for post recon	Recon data is missing or cannot be located	If it is an old series, the raw data may have already been deleted.	Contact Technical Support
46	Error executing protocol. Please register patient before executing protocol	N/A	Trying to perform a scan without a patient being registered due to possible lost Wi-Fi Connection after registration	Re-register a patient and try again or restart Tablet
47	HVG Latch Error message—HE Flow Switch Open (heat exchanger off)	N/A	N/A	Retry executing command first and then restart the scanner. If message does not clear, contact Technical Support
48	HVG Latch Error DAS Data Fault (Bad Detector/Module)	N/A	N/A	Retry executing command first and then restart the scanner. If message does not clear, Contact Technical Support

Error-code number	Fault description	Explanation	Cause <sup>2</sup>	Resolution
49	HVG Latch Error ACQ Rotate Limit	N/A	N/A	Retry executing command first and then restart the scanner. If message does not clear, Contact Technical Support
50	HVG Filament Error	N/A	N/A	Retry executing command first and then restart the scanner. If message does not clear, Contact Technical Support
51	Protocol Rejected Battery	Not enough battery capacity needed to perform scan	Scanner batteries are low	Plug scanner in, ensure breaker is flipped on.
52	XBT_Error (Disk HW related)	X-rays were terminated due to a software anomaly	Scans that result in X-ray Below Threshold (XBT) can result in missing images due to system being allowed to complete scan	Contact Technical Support for service

## Appendix C Emergency Service Kit Procedure

### Introduction

#### Purpose

The Purpose for this document is to explain how to use the Emergency Jack Kit in case the OmniTom fails during transport (either from failing battery or other failure with the transport components).

#### Lifting the OmniTom

If the OmniTom is in TRANSPORT mode (scanner raised) proceed to Section 3.1

If the OmniTom is in SCAN mode (scanner lowered) proceed to Section 3.2

#### In Transport Mode

##### Jacking Up the OmniTom

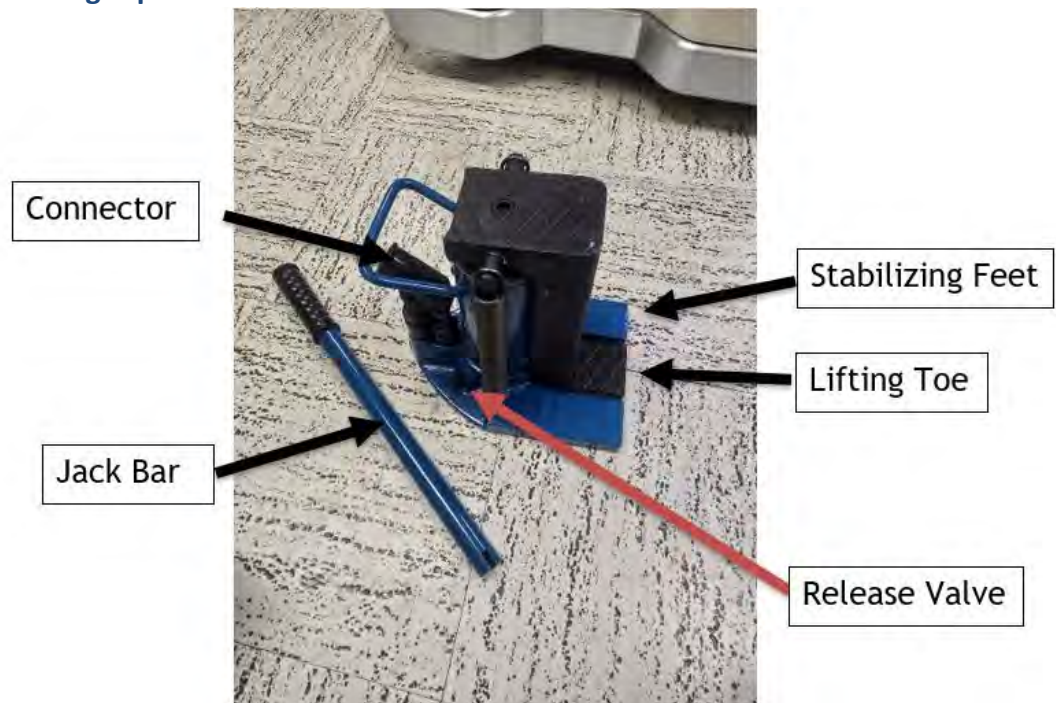

Figure 274: Jack Components



Figure 275: Closeup of Release Valve

- 1) Place the jack near one end of the scanner.
- 2) Make sure the jack is in its lowest position by putting the jack bar over the release valve and twisting it counterclockwise. The lifting toe of the jack should be level with the stabilizing feet.
- 3) Put the spacer block (50-03556-001) on the jack lower tab.

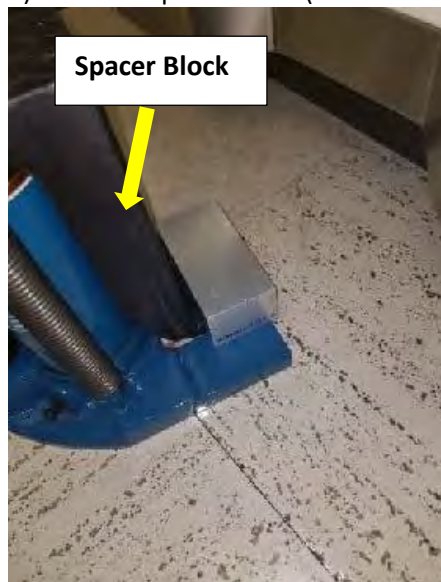

Figure 276: Placement of space block

- 4) Make sure the release valve is then tightened by using the jack bar and twisting it in a clockwise direction.



Figure 277: Using the release valve

- 5) Slide the jack and spacer under the rugged bumper, making sure the spacer is still lined up with the jack.



**CAUTION:** Confirm the system is fitted with ruggedized bumpers before attempting to jack the system up by the bumpers. Systems with non-ruggedized bumpers will not support the weight of the scanner and will be damaged by doing so.

- 6) Insert the jack bar back into the connector.



Figure 278: Inserting the jack bar

- 7) Using the jack bar, slowly start jacking up the side of the scanner.



Figure 279: Proper placement of Jack

- 8) Once the Omniwheels on the side you are jacking up have lifted off the ground with enough room for the dollies, slide the dollies under the Omniwheels (one under each Omniwheel).



Figure 280: Move the dollies into place



**CAUTION:** Lift only as high as required to slide the dollies under the Omniwheels

### Positioning the Dolly

- 1) Make sure the dolly is lined up tight with the Omniwheel.



**CAUTION:** If not placed properly, the Omniwheel could slide off the dolly while trying to move the scanner.



Figure 281: Correct placement of Omniwheel on dolly

### Lowering the OmniTom onto the dolly

- 1) Once the two dollies are in place, remove the jack bar
- 2) Put the jack bar over the release valve and very slowly start to twist the bar counterclockwise until the jack starts to lower



**CAUTION:** This needs to be done slowly. If released too quickly the scanner will drop onto the dollies, possibly displacing them.

Repeat steps 3.1.1 through 3.1.3 for the other side of the scanner.

## In Scan Mode

### Jacking up the OmniTom

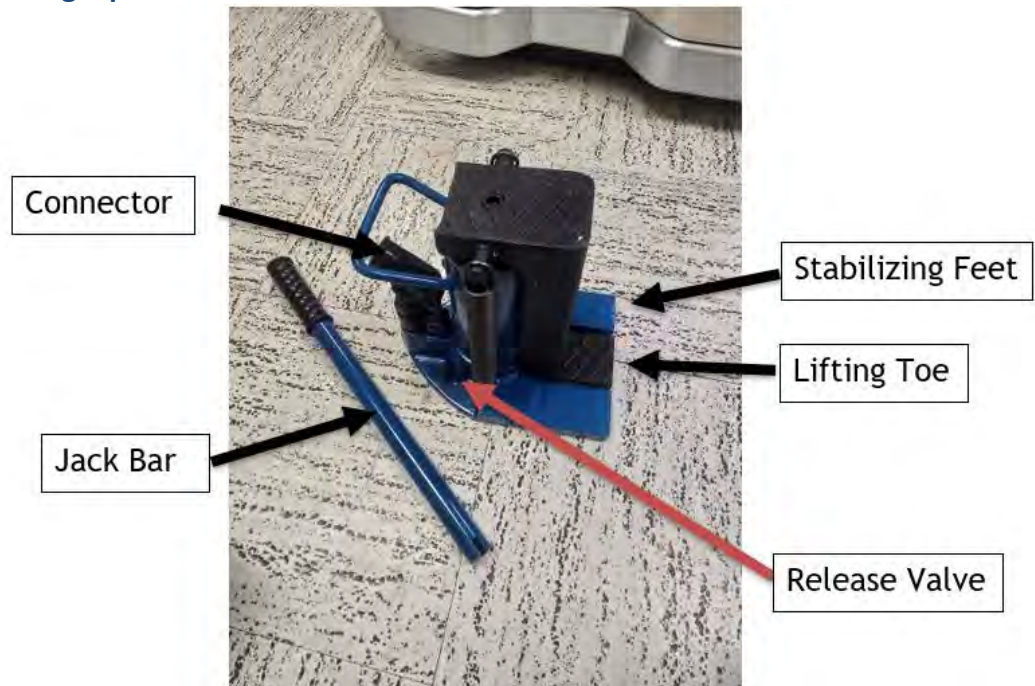

Figure 282: Jack Components

- 1) Place the jack near one end of the scanner.
- 2) Make sure the jack is in its lowest position by putting the jack bar over the release valve and twisting it counterclockwise. The lifting toe of the jack should be level with the stabilizing feet.



Figure 283: Using the release valve

- 3) Make sure the release valve is then tightened by using the jack bar and twisting it clockwise.
- 4) Slide the jack under the rugged bumper.



**CAUTION:** Confirm the system is fitted with ruggedized bumpers before attempting to jack the system up by the bumpers. Systems with non-ruggedized bumpers will not support the weight of the scanner and will be damaged by doing so.

- 5) Insert the jack bar back into the connector.



Figure 284: Inserting the jack bar

- 6) Using the jack bar, slowly start jacking up the side of the scanner.



Figure 285: Jacking up the Scanner



**CAUTION:** Lift only as high as required to slide the dollies under the Omniwheels

- 7) Once the Omniwheels on the side you are jacking up have lifted off the ground with enough room for the dollies, slide the dollies under the Omniwheels (one under each Omniwheel).

## Positioning the Dollies

- 1) Make sure the dolly is lined up tight with the Omniwheel.



**CAUTION:** If not placed properly, the Omniwheel could slide off the dolly while trying to move the scanner.



Figure 286: Correct placement of Omniwheel on dolly



Figure 287: Proper placement of dolly

## Lowering the OmniTom onto the Dolly

- 1) Once the two dollies are in place, remove the jack bar
- 2) Put the jack bar over the release valve and very slowly start to twist the bar counterclockwise until the jack starts to lower



**CAUTION:** This needs to be done slowly. If released too quickly the scanner will drop onto the dollies, possibly displacing them.

**Repeat steps 3.1.1 through 3.1.3 for the other side of the scanner.**

## Moving the OmniTom

Once the scanner has been placed on the dollies it is ready to move out of the room.

The scanner weight is roughly 1,700lbs. It will need at least two people to move the scanner.

If the scanner was in Scan Mode, the clearance under the scanner is very small; approximately 5mm. Keep this in mind if you need to move the scanner over uneven surfaces such as a door threshold or into/out of an elevator.



**CAUTION:** The Emergency Lift Kit is not designed to be used to move the scanner long distances nor be loaded on an elevator. The dolly wheels are small and could get stuck in the gap between the elevator floor and hallway floor.



**CAUTION:** Do not use the drive bar to push or pull the scanner.

## Appendix D      Revision History

Rev	ECO #/Date	Author	Description
00	ECO-003447 2017/08/04	Christofer Krueger	Initial Release
01	ECO-004049 2018/07/30	Ashleigh Young	Significant changes to Operating Instructions due to UI updates
02	ECO-004157 2018/10/23	Ashleigh Young	Significant changes to Operating Instructions due to UI updates
03	ECO-004213 2019/02/08	Ashleigh Young	Significant changes to Operating Instructions due to UI updates
04	ECO-004423 2019/05/17	Stephen Lombardozzi	Significant changes to Operating Instructions to comply with 04-00.04 software version.
05	ECO-004487 2019/08/09	Stephen Lombardozzi	Significant changes to Operating Instructions to comply with 05.00.00 software version.
06	ECO-004754 2020/03/03	Christofer Krueger	Added details to comply with IEC 60825-1, 3 <sup>rd</sup> ed. Table 2 and Laser Safety section of Chapter 1. EU MDR updates: Added Serious Injury, Electronic Copy and Clinical Benefit notes to the preface. Relocated Intended use of the system from chapter 1 to the preface.
07	ECO-004919 2020/06/17	Christofer Krueger	Added FDA Laser warning statement. Updated marking plate. To address IEC 60601-1-2, clause 5: Added a new Table 15 on separation distance, note on EMC characteristics now added before Table 11. A note on Wireless bandwidths was added after Table 12. A Warning symbol was also added to a statement in Table 13. Update Scatter plot.
08	ECO-005035 2020/09/04	Christofer Krueger Ibrahim Bechwati	Added Sensitivity profile and slice thickness statements (Figures 75 and 76). Added Warning statements for the Battery on the BPD. Pages 58 and 61.
09	ECO-005248 2021/02/02	Stephen Dunn Karen Reed Gina Cunsolo	Added OmniTom Elite and MSU options. Updated rear curtain details, updated dimensions for system, added details on tube seasoning. Updates to symbol table.
10	ECO-005562 2021/06/29	Karen Reed Keith Kaser Gina Cunsolo	Updated Symbols Table to reflect current. Updated Appendix D. Updated E-Stop Information Added Drive View Updated Positioning Patient Information Added Alignment Camera Updated Dose Configuration Added Reconstruction Presets Added MPR Presets

Rev	ECO #/Date	Author	Description
			<p>Added Hiding Protocols            Added Moving Protocols            Updated Registering Patient Information            Updated Storing Patients in Stored List            Updated AEC Information            Added Performing a Perfusion Scan            Added Editing Patient Details            Updated Archiving Patient Images            Updated Viewing Images in CTP            Updated T-Square Handle            Updated Pediatric Scan Platform            Updated Using Infant and Neonate Scan Platform            Removed Using Doro OmniTom Intra-operative Stabilization System            Updated Glossary Section</p>
11	ECO-005494 2022/04/08	Gina Cunsolo Stephen Dunn	<p>Updated CE Mark for NB Number; Update to notes under Customer Contact info for notification of serious incident. Update to Indications to clarify scanning is “primarily for head and neck.” Update to symbols table. Update reference to max scan current (mA) for helical vs. axial. Correction made to product dimensions.</p>
12	ECO-006215 2022/06/30	Gina Cunsolo	Addition of new CE Mark
13	ECO 006355 2022/11/11	Keith A. Kaser Ninad Gujar	<p>Added Photon Counting Detector Information as Chapter 13 and updated following Chapter numbers. Added hazards for certain test case failures to mitigate three different, unique situations. Updated dose in air table.</p>
14	ECO-006543 2023/03/09	Keith A. Kaser	<p>Updated Chapter 13 to include PCD Caution statements and update to Air Calibration information. Updated E-Stop information for accuracy. Modified multiple issues with incorrect Font sizes. Added Caution to contact Technical Support to obtain dose report if issues occur.</p>
15	ECO-006496 2023/07/20	Keith A. Kaser	<p>Updated Intended Use throughout the manual. Added information for new feature ‘Manual Add’ to Chapter 8.            Added information for new feature ‘Compare Series’ to Chapter 10.            Added High Resolution, Virtual Monoenergetic Image, and Material Decomposition information to Chapter 13.</p>

Rev	ECO #/Date	Author	Description
			<p>Updated PCD air calibration section of Chapter 13.</p> <p>Corrected multiple spelling and grammar issues throughout document.</p> <p>Added "Follow Instructions for Use" Symbol</p>
16	ECO-006941 2023/11/25	Keith A. Kaser	<p>Updated Scanning a patient chapter to include Auto Finalize when a scan is complete.</p> <p>Updated PCD Chapter 13 to include new functionality and features.</p>
17	ECO-007246 2024/09/20	Keith A. Kaser Ninad Gujar	<p>Changed cover photo</p> <p>Added note on page 85 related to features not included on MSU Version of scanner.</p> <p>Removed references to Blood maps, specifically old Figure 240.</p> <p>Added "PCD Technical Performance Information" to Chapter 13.</p> <p>Added SmartMSU extreme weather information from Bugzilla# 6037 to page 31.</p> <p>Updated intended use, trade name and device name for clarity</p> <p>Added Note recommending daily restart of tablet.</p> <p>Added Note recommending weekly restart of scanner.</p>
18	ECO-007538 2025/05/06	Keith A. Kaser	<p>Removed PCD Information</p> <p>Added Warning in Safety Information section related to decommissioning system to remove health software.</p> <p>Added a 'Manage Users Section' to Chapter 5.</p> <p>Added 'Deleting a User' to Chapter 5.</p> <p>Added 'Noise Reduction' information.</p> <p>Add 'Adding a New Protocol using Copy from an Existing Protocol' section to Chapter 6.</p> <p>Removed references to Manual Registration in Chapter 8.</p> <p>Added 'Re-using Scouts with a New Protocol' section to Chapter 9.</p> <p>Added Noise Reduction to Scanning with Special Features section.</p> <p>Added 'MSU Image Transfer to Hospital section to Chapter 10.</p> <p>Added information related to ROI Radius.</p> <p>Added Safety Strap Information to Chapter 13.</p> <p>Added Appendix C – Emergency Service Kit Procedure.</p>

## Appendix E Varex Imaging Data



MCS-640

Stationary Anode X-Ray Tube

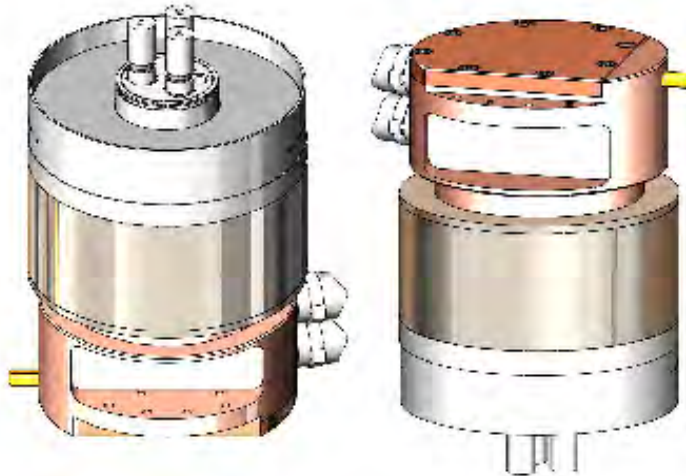

### Product Description

The MCS-640 is a 140 kV, air cooled stationary anode metal ceramic x-ray source. This source is specifically designed for Imaging Applications.

### X-Ray Tube Specifications

Maximum Peak Voltage .....	140 kV
Anode to Ground .....	0 kV
Cathode to Ground .....	140 kV
Focal Spot - IEC 60336	
Small .....	1.0 W x 1.0 L
Cooling Medium .....	Water/Glycol
Maximum Continuous Rating	
Small .....	5400 W with 0.6 gpm coolant flow
Target Material .....	Tungsten-Rhenium
Target Angle .....	5°
Radiation Coverage .....	72°
X-Ray Tube Assembly Permanent Filtration .....	2.0 mm Be



MCS-640

Housing Outline Drawing

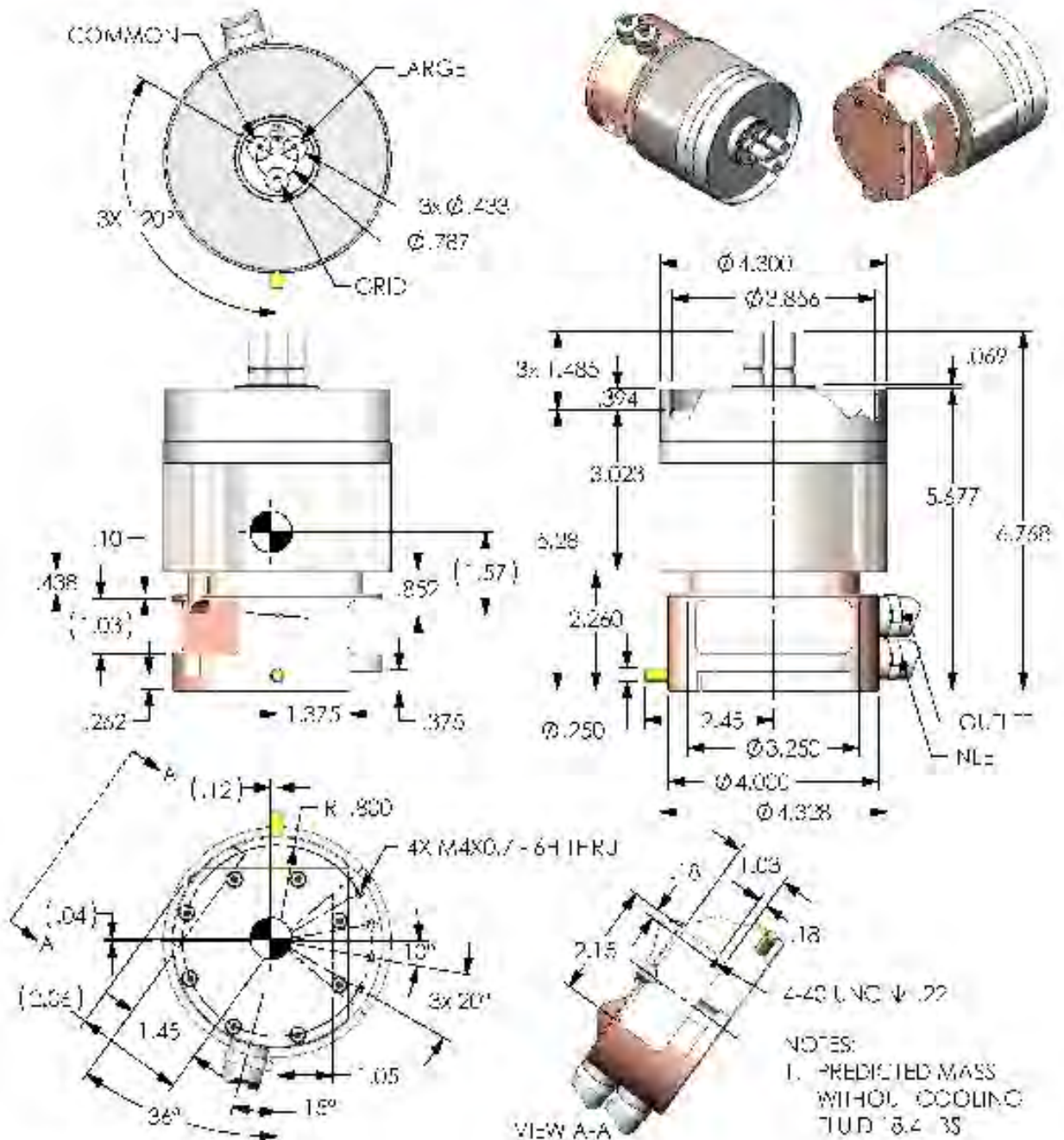

Dimensions are for reference only



MCS-640

Beam Coverage

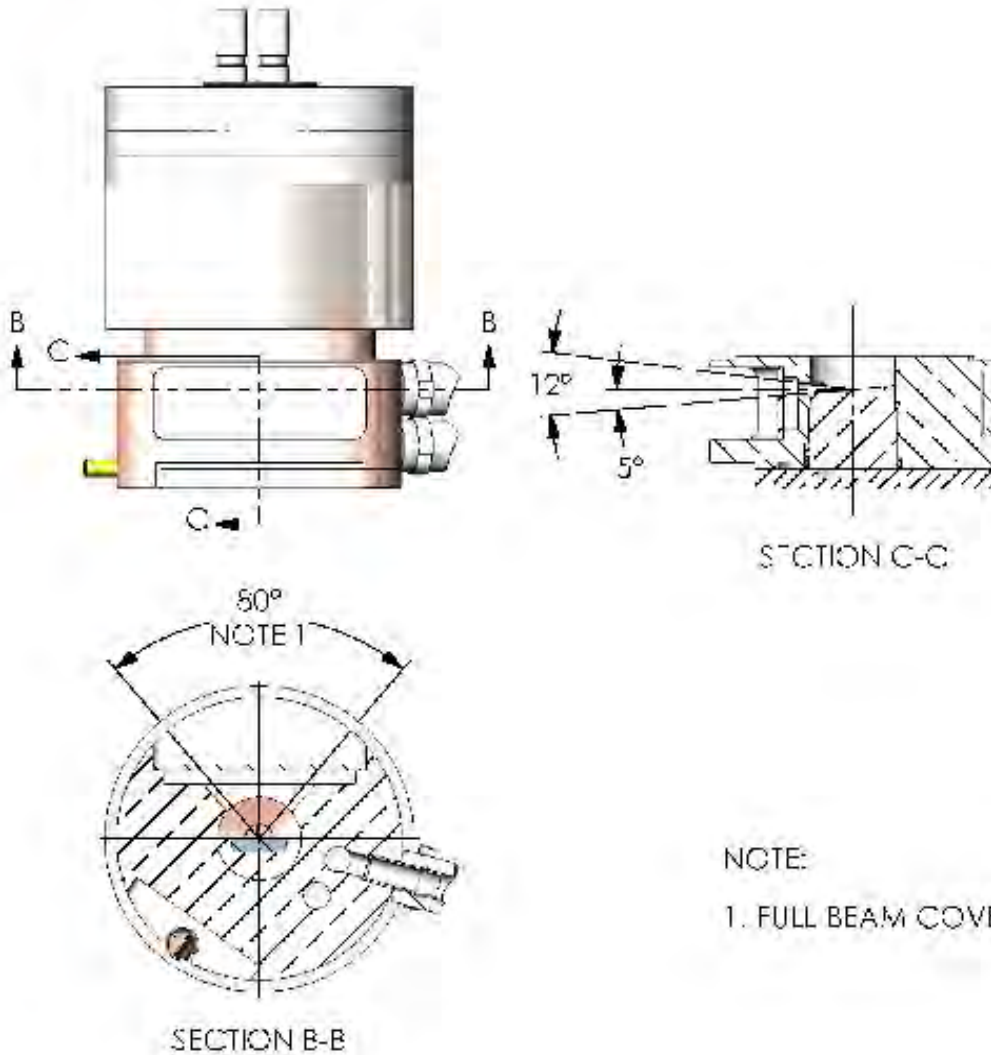

NOTE:  
1. FULL BEAM COVERAGE



MCS-640

Rating Charts

### MCS-640 Filament Characteristics

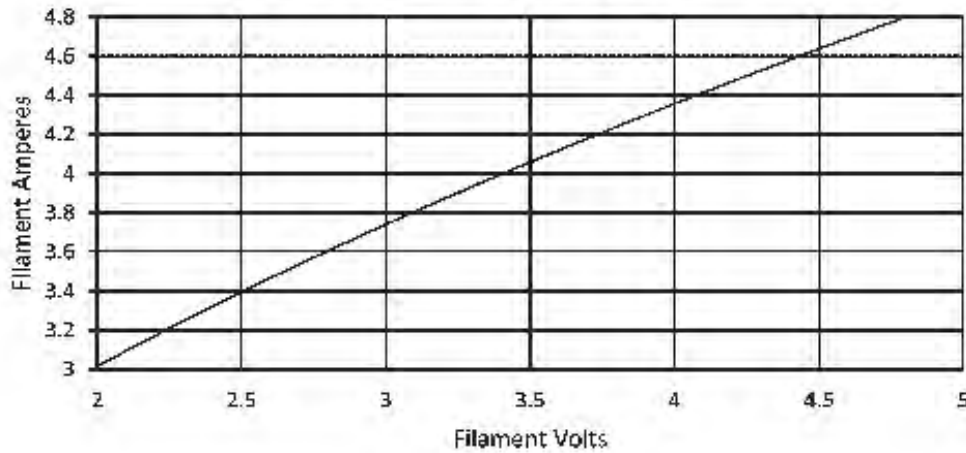

 **WARNING**

Beryllium windows transmit a very high level of long wavelength X-radiation, which can injure human tissue. Injury may occur from even very short exposures to the primary X-ray beam. Follow all precautions necessary to avoid radiation exposure to humans.

The radiation dose rate cannot be accurately measured with conventional radiation measurement instruments. Radiation intensity in each installation will vary, and calibration must include the effects of long wavelength X-radiation.

Fumes from beryllium metal (or its compounds) as well as dust can be hazardous if inhaled. During use, corrosion products may occur on the beryllium window, but these should not be scraped off, machined, or otherwise removed. Tube unit disposal should conform to federal, state, and local regulations governing beryllium.



Salt Lake City, UT 1-801-972-5000  
www.vareximaging.com

Manufactured by Varex Imaging Corporation

Specifications subject to change without notice.

Copyright © 2019, Varex Imaging Corporation. All Rights Reserved.